

TEGAM Inc.

**Model 2732**  
**50 MHz x 2 Channels**  
**Function/Arbitrary Waveform Generator**

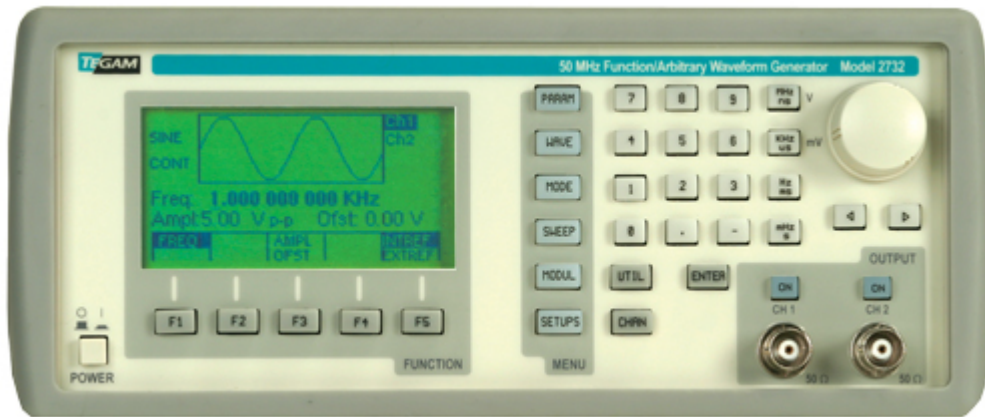

Instruction Manual  
PN# 2732-901-01CD  
Publication Date: July 2007  
REV. D  
© Copyright 2007, TEGAM, Inc. All rights reserved.

NOTE: This user's manual was as current as possible when this product was manufactured. However, products are constantly being updated and improved. Because of this, some differences may occur between the descriptions in this manual and the product received.

<b>I</b>	<b>INSTRUMENT DESCRIPTION.....</b>	<b>1-1</b>
	Instrument Description .....	1-3
	Feature Overview .....	1-4
	Model 2732 Accessories .....	1-5
	Performance Specifications .....	1-6
	Frequency Characteristics .....	1-6
	Arbitrary Characteristics .....	1-6
	Output Characteristics.....	1-6
	Waveform Characteristics .....	1-7
	Operating Modes .....	1-7
	Modulation Characteristics .....	1-7
	Sweep Characteristics .....	1-8
	Variable Phase .....	1-8
	Inputs and Outputs.....	1-8
	Computer Interfaces .....	1-8
	General Specifications .....	1-9
<b>II</b>	<b>PREPARATION FOR USE .....</b>	<b>2-1</b>
	Unpacking and Inspection.....	2-3
	Safety Information and Precautions .....	2-3
	Servicing Safety Summary .....	2-5
	Line Voltage and Fuse Selection .....	2-6
<b>III</b>	<b>QUICK START INSTRUCTIONS.....</b>	<b>3-1</b>
	Introduction .....	3-3
	Power the Unit.....	3-3
	Your First Waveform.....	3-3
	Instrument Settings.....	3-4
	Table 3.1 – Factory Default Settings.....	3-4
	Using the Function Generator.....	3-5
	Downloading a Waveform from WaveWorks DDS to the 2732 .....	3-7
	Using WaveWorks DDS to Create an Arbitrary Waveform .....	3-8
	General Tips for Usage.....	3-9
<b>IV</b>	<b>OPERATING INSTRUCTIONS.....</b>	<b>4-1</b>
	General Description .....	4-3
	Front Panel.....	4-3
	Figure 4.1 – Model 2732 Front Panel .....	4-3
	Display Window.....	4-4
	Front Panel Controls .....	4-4
	Front Panel Output Connectors.....	4-4
	Rear Panel .....	4-5
	Figure 4.2 – Model 2732 Rear Panel .....	4-5
	Rear Panel Input Connectors.....	4-6
	Rear Panel Output Connectors.....	4-6

**IV OPERATING INSTRUCTIONS CONT'D.....**

MENU Keys .....	4-7
[PARAM] Parameter Menu.....	4-7
Figure 4.3 – Parameter Menu Tree .....	4-7
Frequency/Rate.....	4-7
Amplitude.....	4-8
Table 4.1 –Waveform Amplitudes (Examples) .....	4-8
Offset .....	4-9
Table 4.2 – Voltage Offset Ranges .....	4-9
Amplitude Units.....	4-10
Internal/External Reference .....	4-10
[WAVE] Wave Menu.....	4-11
Figure 4.4 – Wave Menu Tree.....	4-11
Pulse .....	4-12
Figure 4.5 – Definition of 10-90% Lead and Trail.....	4-13
Figure 4.6 – Definition of Width, Leading and Trailing Edges .....	4-13
Figure 4.7 – Definition of Period & Width.....	4-13
Arbitrary Waveform Menu .....	4-15
Table 4.3 –Length Limits for Predefined Waveforms.....	4-20
[MODE] Trigger Mode Menu .....	4-24
Figure 4.8 – Trigger Mode Menu Tree .....	4-24
[SWEEP] Sweep Menu.....	4-27
Figure 4.9 – Sweep Menu Tree .....	4-27
[MODUL] Modulation Menu .....	4-29
Figure 4.10 - Modulation Menu Tree .....	4-29
[SETUPS] Setups Menu .....	4-33
Figure 4.11 – Setups Menu Tree .....	4-33
Front Panel Keys .....	4-35
[UTIL] Utility Menu .....	4-35
Figure 4.12 – Utility Menu Tree.....	4-35
[ON] ON Key .....	4-37
[◀][▶] Cursor Movement Keys.....	4-37
Rotary Input Knob .....	4-37
Power On Settings .....	4-37
[ENTER] Enter Key .....	4-37
UNITS Keys .....	4-37
Power-On Settings.....	4-38
Table 4.4 – Power On Default Settings (Location 0) .....	4-38
Instrument Operation .....	4-39
Impedance Matching.....	4-39
Waveform and Execution Memory .....	4-40
Displaying Errors.....	4-41
Table 4.5 – Error Messages for the 2732.....	4-41
Using the Model 2732 .....	4-42
Generating a Standard Waveform .....	4-43
Defining a Pulse Waveform .....	4-44
Creating an Arbitrary Waveform .....	4-45
Example Text File.....	4-45

<b>IV</b>	<b>OPERATING INSTRUCTIONS CONT'D</b> .....	
	Creating an Arbitrary Waveform: Loading Individual Data Points .....	4-46
	Defining a Wave Segment for Execution .....	4-47
	Creating a Complex Arbitrary Waveform .....	4-48
	Figure 4.13 – Sine Wave with Superimposed Noise and Glitches.....	4-51
	Setting the Frequency .....	4-52
	Generating a Waveform Output .....	4-53
	Modifying a Waveform's Output .....	4-53
	Using Voltage Offset .....	4-53
	Storing and Recalling a Waveform Generator Setup.....	4-54
	Generating and Transferring Data from WaveWorks DDS to Model 2732 .....	4-55
<b>V</b>	<b>PROGRAMMING AND INTERFACING</b> .....	<b>5-1</b>
	BNC Input and Output Connections.....	5-3
	Front Panel Output Connectors .....	5-3
	Rear Panel Input Connectors.....	5-4
	Rear Panel Output Connectors.....	5-5
	RS-232C Programming.....	5-6
	General.....	5-6
	Figure 5.1 – Cable End View .....	5-6
	Table 5.1 – Pin Designations for RS-232C Cable.....	5-6
	RS-232C Operation.....	5-7
	GPIB Interface .....	5-8
	Overview .....	5-8
	Figure 5.2 – GPIB Connector Pin Assignments .....	5-8
	Device State .....	5-9
	Interface Function Subsets .....	5-10
	Device Address .....	5-10
	Message Exchange Protocol .....	5-10
	Block Data.....	5-12
	Instrument Identification.....	5-12
	Instrument Reset .....	5-12
	Self Test .....	5-12
	Command Syntax.....	5-13
	Status Reporting .....	5-18
	Error Codes .....	5-20
	Table 5.2 – Summary of Command Errors.....	5-20
	Table 5.3 – Summary of Execution Errors .....	5-21
	Table 5.4 – Summary of Device Specific Errors .....	5-21
	Table 5.5 – Summary of Query Errors .....	5-22
	Table 5.6 – Summary of System Events .....	5-22
	Table 5.7 – Summary of Warnings.....	5-23

<b>V</b>	<b>PROGRAMMING AND INTERFACING CONT'D.....</b>	
	IEEE 488.2 Common Commands .....	5-24
	Instrument Control Commands .....	5-29
	SOURce Subsystem .....	5-30
	OUTPut Subsystem.....	5-50
	TRIGger Subsystem .....	5-51
	ARBitrary Subsystem.....	5-53
	STATus Subsystem.....	5-63
	SYSTem Subsystem.....	5-68
	IEEE 488.1 Interface Messages .....	5-71
	SCPI Command Trees .....	5-72
	Figure 5.3 - Root Node Tree.....	5-72
	Figure 5.4 - :SOURce Subsystem Tree.....	5-72
	Figure 5.5 - :OUTPut Subsystem Tree .....	5-73
	Figure 5.6 – TRIGger Subsystem Tree .....	5-73
	Figure 5.7 – ARBitrary Subsystem Tree .....	5-74
	Figure 5.8 – STATus Subsystem Tree .....	5-75
	Figure 5.9 – SYSTem Subsystem Tree .....	5-76
	Table 5.8 – ASCII & GPIB Code Chart.....	5-77
	Block Transfer .....	5-78
	GPIB Communication Protocol .....	5-80
	IEEE-488.2 Interface Function Subsets .....	5-83
	Table 5.9 – Interface Function Subsets .....	5-84
<b>V</b>	<b>SERVICE INFORMATION.....</b>	<b>6-1</b>
	Warranty .....	6-3
	Warranty Limitations .....	6-3
	Statement of Calibration .....	6-3
	Contact Information .....	6-3
	Repair Parts .....	6-4
	Troubleshooting .....	6-5
	Preparation for Repair or calibration Service.....	6-6
	Expedite Repair and Calibration Form.....	6-7
	Model 2732 Performance Verification.....	6-8
<b>VI</b>	<b>APPENDIX .....</b>	<b>A.1</b>



**INSTRUMENT DESCRIPTION**  
PREPARATION FOR USE  
QUICK START INSTRUCTIONS  
OPERATING INSTRUCTIONS  
PROGRAMMING & INTERFACING  
SERVICE INFORMATION  
APPENDIX

Model 2732: Two Channel 50 MHz Function/Arbitrary Waveform Generator  
**Instrument Description**

---



## **Instrument Description**

---

### **Instrument Description:**

This manual contains information required to operate, program and test the 2732 Function/Arbitrary Waveform Generator. This section covers the general description, instrument specifications and characteristics.

The 2732 is a versatile, high performance signal generator featuring dual functionality. It combines two channels of direct digital synthesis (DDS)-based, 50 MHz function generators and two, true arbitrary waveform generators with up to 4 MB of waveform memory per channel and a 125 MS/s clock speed per channel. The dual functionality makes the instrument ideal for general-purpose, high-speed laboratory use or low cost production test applications. Operation is simple and precise waveforms can be created and produced using the included software.

As a function generator, the 2732 has the capability to produce sine, square, triangle/ramp, and pulse waveforms. Each wave type has user-definable parameters. AM, FM and FSK are available with internal or external modulation. The unit also includes sweep capabilities making it suitable for a wide range of communications applications. The Model 2732 also includes a programmable sync pulse (in arbitrary mode) where the start address and width of the pulse may be user-defined. This allows synchronization of external instruments including additional function generators and digital samplers.

Two independent arbitrary waveforms can be programmed and generated with 14-bit resolution and up to 4 Million points per channel. Waveforms can be output in continuous, triggered, gated or burst mode with an internal or external 10 MHz clock reference.

Editing is flexible and includes line drawing and ten predefined waveform utilities. Predefined arbitrary wave types include sine, triangle, square, noise,  $\sin(x)/x$ , gaussian, exponential up/down and ramp up/down. In addition, custom wave types may be created, edited, and downloaded using WaveWorks DDS or other software solutions offered by TEGAM.

The instrument can be remotely operated via the standard GPIB (IEEE-488.2) or RS-232C interfaces and is SCPI compatible. USB control is also available using an optional USB to RS-232 converter.

## Instrument Description

---

### Feature Overview

#### **DDS Flexibility with Arbitrary Waveform Precision**

TEGAM's 2732 combines the advantages of a true arbitrary waveform generator with the advantages of a direct digital synthesis (DDS) generator. Its proprietary design makes the 2732 extremely versatile for sweep, modulation, pulse, and integration applications without losing valuable arbitrary wave data through unnecessary digital processing.

#### **Standard Waveforms from 1 $\mu$ Hz to 50 MHz**

In the function generator mode, sine and square waves are available from 1  $\mu$ Hz to 50 MHz. Triangle/ramp waveforms are available from 1  $\mu$ Hz to 5 MHz. Pulse waveforms may be produced from 500  $\mu$ Hz to 25 MHz.

#### **Internal/External AM, FM, or FSK functions**

Model 2730 has the capability to modulate standard waveforms from an internal or external, 0 V to 5 V source. AM & FM are available from 0.01 Hz to 20 kHz. FSK is available from 0.01 Hz to 1 MHz internally and limited to 1 MHz externally.

#### **Arbitrary Wave Creation**

In addition to operating as a function generator, the 2730 may be operated in its arbitrary waveform mode. Custom waveforms may be imported, created or edited using WaveWorks DDS software or the instrument's front panel. The user defines the range (any segment between 1 to 4,000,000) of arbitrary wave data to be executed.

#### **Wave Creation Software**

Windows-based, WaveWorks DDS is provided at no additional charge. The user can create, import, edit, download/upload data to/from the instrument using WaveWorks DDS. WaveWorks DDS also has the ability to download wave data directly from select Tektronix, Agilent, and LeCroy oscilloscopes.

#### **0.01 Hz to 125 MS/s Sampling Speed**

The execution of arbitrary wave data can be varied from .01 Hz to 125 MS/s. The wide sampling range offers exceptional flexibility for wave data storage and execution.

#### **8 MB of Arbitrary Wave Memory (4MB x 2 Channels)**

The Model 2732 offers two channels of 4 MB wave memory enabling up to 4 Million points of data per waveform per channel. No other function/arbitrary waveform generator in its class offers this much memory.

#### **Programmable Synchronous Output (Marker)**

In arbitrary wave mode, a fully programmable TTL marker pulse allows external synchronization with arbitrary waveform data points. The width and starting address of the pulse are user-defined between address locations 1 through 4,000,000.

#### **RS-232C and GPIB Interfaces**

GPIB and RS-232C interfaces are included at no additional charge.

#### **3-Year Warranty**

TEGAM stands behind this product and backs it with a full 3-year warranty.

Model 2732: Two Channel 50 MHz Function/Arbitrary Waveform Generator  
**Instrument Description**

**Model 2732 Accessories**



**2701 – Single Unit Rack Mount Kit**  
Fits most standard 19" racks. Mounting hardware included.



**2702 – Dual Unit Rack Mount Kit**  
Fits most standard 19" racks. Mounting hardware included.



**CBL-3102 – BNC Cable**  
3-ft BNC cable used for general purpose I/O connections.



**BNC-3285 – BNC (F-M-F)  
BNC Tee Connector**

Used for splitting 50  $\Omega$ , BNC-type connections used for trigger, main output, modulation, and sync I/O's.



**1583-3 – 3ft Heavy Duty GPIB Cable**  
**1583-6 – 6ft Heavy Duty GPIB Cable**  
**1583-9 – 9ft Heavy Duty GPIB Cable**

**NO PHOTO  
AVAILABLE**

**2732-901-01 – 2732 User's Manual  
Printed Version**



**1000030-840-01**

- **2732 User's Manual**
- **WaveWorks DDS Wave Creation Software**
- **LabVIEW Drivers**

*(Included Accessories)*



**740565-6 - 6 ft RS-232C Cable**  
DB9F to DB9F RS-232C, null modem communication cable for the Model 2732.  
*(Included Accessory)*



**161006600 – Power Cord for 120 VAC  
Operation**  
Contact TEGAM for alternate voltages.  
*(Included Accessory)*



**1000001 - USB to RS232 Converter**  
Allows serial communication between the Model 2732 RS232 interface and a USB enabled PC. Kit includes software driver for Windows 98SE/ME/2000/XP, Mac 8.6/9/10, and Linux 2.4 and higher.

## Instrument Description

---

### 2732 Performance Specifications (Channel Independent):

#### Frequency Characteristics (Standard Waveforms)

Sine	- 1 $\mu$ Hz to 50 MHz
Square	- 1 $\mu$ Hz to 50 MHz
Triangle, Ramp	- 1 $\mu$ Hz to 5 MHz
Pulse	- .5 MHz to 25 MHz
Frequency Accuracy	- 0.002% (20 ppm)
Frequency Resolution	- 12 digits or 1 $\mu$ Hz

#### Arbitrary Characteristics

Waveform length	- 2 points to 4 M points
Vertical resolution	- 14 bits
Sampling rate	- .01 S/s to 125 MS/s (8 ns to 100 s)
Sampling Accuracy	- 0.002% (20 ppm)
Sampling Resolution	- 4 digits or 1 ps

#### Output Characteristics

Amplitude Range	- 10 mV to 10 Vp-p into 50 $\Omega$
Resolution	- 3 digits (1000 counts)
Amplitude Accuracy	- $\pm 1\%$ $\pm 20$ mV of the programmed output from 1 V-10 V
Flatness	- 0.1 dB to 1 MHz - 1.0 dB to 50 MHz
Offset Range	- $\pm 4.99$ V into 50 $\Omega$ , dependent on the amplitude setting
Offset Resolution	- 10 mV with 3 digits resolution
Offset Accuracy	- $\pm 1\%$ $\pm 10$ mV into 50 $\Omega$
Output Impedance	- 50 $\Omega$
Output Protection	- The instrument output is protected against short circuit or 42 V maximum input voltage.
Filters	- 9-pole Elliptic and 5-pole Bessel filters

## Instrument Description

---

### 2732 - Specifications cont'd:

#### Waveform Characteristics

- |  |   |  |           |
|--|---|--|-----------|
| Harmonic Distortion  | - | DC-20 kHz  | -65 dBc   |
|  | - | 20 kHz-100 kHz                                   | -60 dBc   |
|  | - | 100 kHz-5 MHz                                    | -45 dBc   |
|  | - | 5 MHz-50 MHz                                     | -30 dBc   |
| <br>Spurious   | - | DC-1 MHz   | < -65 dBc |
| <br>Variable Duty Cycle  | - | 20% to 80% to 10 MHz,<br>40% to 60% up to 30 MHz |           |
| <br>Symmetry at 50%  | - | < .5%  |           |
| <br>Aberrations  | - | < 3% of p-p amplitude $\pm$ 50 mV.               |           |
| <br>Square Rise/Fall Time<br>(10-90%) $V_{max}$ into 50 $\Omega$ | - | < 6 ns   |           |

#### Operating Modes

- |                       |   |  |
|-----------------------|---|--|
| Continuous            | - | Output continuous at programmed parameters.  |
| Triggered             | - | Output at rest until triggered by an internal or external trigger, then one waveform cycle is generated to programmed parameters. Up to 20 MHz trig rate for ARB waveforms and 10 MHz in DDS mode. |
| <br>Gate              | - | Same as triggered mode, except waveform is executed for the duration of the gate signal. The last cycle started is completed.  |
| <br>Burst             | - | 2 - 999,999 cycles   |
| Phase                 | - | -360° to +360°, 0.1° resolution  |
| Trigger Source        | - | Trigger source may be internal, external or manual.  |
| Internal Trigger Rate | - | 0.01 Hz-1 MHz, 4 digits resolution, $\pm$ 0.002% accuracy  |

#### Modulation Characteristics

- |                          |   |  |
|--------------------------|---|--|
| Amplitude Modulation     | - | 0.01 Hz-20 kHz sine, square or triangle wave<br>Variable modulation from 0% to 100%. |
| - Internal:              | - |  |
| - External:              | - | 5 Vp-p for 100% modulation, 10 k $\Omega$ input Z.                                   |
| <br>Frequency Modulation | - | 0.01 Hz-20 kHz sine, square, or triangle wave  |
| - Internal:              | - |  |
| - External:              | - | 5 Vp-p for 100% deviation, 10 k $\Omega$ input Z.                                    |
| <br>FSK                  | - | 0.01 Hz-1 MHz sine, square, or triangle wave   |
| - Internal rate          | - |  |
| - External               | - | 1 MHz max  |

## Instrument Description

---

### 2732 - Specifications cont'd:

#### Sweep Characteristics

- |               |   |
|---------------|---|
| Sweep Shape:  | - Linear and Logarithmic, up or down      |
| Sweep Time:   | - 10 ms to 500 s.                         |
| Sweep trigger | - internal, external, continuous or burst |

#### Variable Phase

- |            |                    |
|------------|--------------------|
| Range      | - +360 ° to -360 ° |
| Resolution | - 0.1 °            |

#### Inputs and Outputs

- |                  |   |
|------------------|---|
| Trigger In       | - TTL compatible.<br>- Maximum rate of 20 MHz.<br>- Minimum width of 20 ns.<br>- Input impedance 10 kΩ nominal. |
| Sync Out         | - +TTL pulse at programmed frequency, 50 Ω source Z.<br>(fan out =40)   |
| Modulation In    | - 5 Vp-p for 100% modulation.<br>- 10 kΩ input impedance.<br>- DC to >50 kHz minimum bandwidth.                 |
| Reference IN/OUT | - 10 MHz, TTL compatible I/O, 50 Ω Output Z, 1 kΩ Input Z<br>(fan out =40)                                      |
| Marker Out       | - A positive TTL pulse user programmable in arbitrary waveform mode. 50 Ω source impedance. (fan out =40)       |
| Summing Input    | - 5 Vp-p signal for full-scale output, 500 Ω input Z.   |

#### Computer Interfaces:

- |         |                              |
|---------|------------------------------|
| GPIB    | - IEEE 488.2 SCPI compatible |
| RS-232C | - 115k baud, max.            |

## Instrument Description

---

### 2732 - Specifications cont'd:

#### General Specifications

Settings Storage	- 49 user defined, non-volatile settings
Arbitrary memory	- 8 MB in flash memory (4 MB / Channel)
Dimensions	- Width = 8.4 in. (213 mm) - Height = 3.5 in. (88 mm) - Depth = 10.8 in. (275 mm)
Weight	- 5.66 lbs. (2.57 Kg.)
Power	- < 50 VA max.
Supply Voltage	- 110 V/220 V (100 V to 240 VAC, $\pm 10\%$ )
Line Frequency	- 50/60 Hz (47 Hz to 63 Hz)
Operating Temperature	- 32°F to 122°F (0°C to +50°C)
Storage Temperature	- -22°F to 160°F (-30°C to +71°C)
Humidity	- 90% RH, 32°F to 86°F (0°C to 30°C)
EMC	- According to EN55011 class B for radiated and conducted emissions.
ESD Immunity	- According to EN55082
Safety Specifications	- According to EN61010 - CE certified

**NOTE:** Specifications are verified according to the performance check procedures in the technical manual. Specifications not verified in the manual are either explanatory notes or general performance characteristics only.

## **Instrument Description**

---



INSTRUMENT DESCRIPTION  
**PREPARATION FOR USE**  
QUICK START INSTRUCTIONS  
OPERATING INSTRUCTIONS  
PROGRAMMING & INTERFACING  
SERVICE INFORMATION  
APPENDIX

Model 2732: Two Channel 50 MHz Function/Arbitrary Waveform Generator  
**Preparation for Use**

---

Model 2732: Two Channel 50 MHz Function/Arbitrary Waveform Generator  
**Preparation for Use**

---

### Unpacking & Inspection:

Each 2732 is put through a series of electrical and mechanical inspections before shipment to the customer. Upon receipt of your instrument unpack all of the items from the shipping carton and inspect for any damage that may have occurred during transit. Report any damaged items to the shipping agent. Retain and use the original packing material for reshipment if necessary.

Upon Receipt, inspect the carton for the following items:



- (1) Model 2732 – Two Channel 50 MHz Function/Arbitrary Waveform Generator
- (1) CD: Model 2732 User's Manual, WaveWorks DDS (Wave Creation Software), LabVIEW Drivers
- (1) RS-232C Cable
- (1) Power Cord

### Safety Information & Precautions:

The following safety information applies to both operation and service personnel. Safety precautions and warnings may be found throughout this instruction manual and the equipment. These warnings may be in the form of a symbol or a written statement. Below is a summary of these precautions. TEGAM assumes no liability for a customer's failure to comply with these requirements. Model 2732 is a Safety Class I instrument.

#### **Terms in This Manual:**

**CAUTION** statements identify conditions or practices that could result in damage to the equipment or other property.

**WARNING** statements apply conditions or practices that could result in personal injury or loss of life.

#### **Terms as Marked on Equipment:**

**CAUTION** indicates a personal injury hazard not immediately accessible as one reads the marking, or a hazard to property including the equipment itself.

**DANGER** indicates a personal injury hazard immediately accessible as one reads the marking.

Model 2732: Two Channel 50 MHz Function/Arbitrary Waveform Generator  
**Preparation for Use**

---







 **Safety Information & Precautions Cont'd:**

**Symbols:**

*As Marked in This Manual:*

	This symbol denotes where precautionary information may be found.
---	---

*As Marked on Equipment:*

	Caution – Risk of Danger
	Danger – Risk of Electric Shock
	Earth Ground Terminal-
I	On
O	Off
	Chassis Terminal
	Alternating Current
	Earth Ground Terminal / Guard

**Grounding the Equipment**

This product is grounded through the grounding conductor of the power cord.



**WARNING:** To avoid electrical shock or other potential safety hazards, plug the power cord into a properly wired receptacle before using this instrument. The proper grounding of this instrument is essential for safety and optimizing instrument operation. The power cord must meet IEC safety standards.

**Danger Arising from Loss of Ground**

**WARNING:** If the connection to ground is lost or compromised, a floating potential could develop in the instrument. Under these conditions all accessible parts, including insulating parts such as keypads and buttons could develop a hazardous voltage and put the user at risk.

## Preparation for Use

---



### **Use the Proper Fuse**

To avoid fire hazard, use only the correct fuse type as specified for the AC power supply in the "Preparation for Use" or "Service" sections of this manual. Note that the fuse rating for 100-volt and 120-volt operation is different than the rating for 200-volt and 240-volt operation. Information about the proper fuse type is also printed on the rear panel of the instrument.

Refer fuse replacement to qualified service personnel.

### **Do Not Use in Explosive Environments**

**WARNING:** The 2732 is not designed for operation in explosive environments.

### **Do not Operate Without Covers**

**WARNING:** This device should be operated with all panels and covers in place. Operation with missing panels or covers could result in personal injury.

## FOR QUALIFIED SERVICE PERSONNEL ONLY



### **Servicing Safety Summary:**

#### **Do Not Service Alone**

Do not perform service or adjustment on this product unless another person capable of rendering first aid is present.

#### **Use Care When Servicing with Power On or Off**

Dangerous voltages may exist at several points in this product. To avoid personal injury or damage to this equipment, avoid touching exposed connections or components while the power is on. Assure that the power is off by unplugging the instrument when removing panels, soldering, or replacing components.



**WARNING:** The instrument power source is electronically controlled meaning that there is power present throughout the instrument even when the instrument is in the OFF state. Always unplug the instrument and wait 5 minutes before accessing internal components.

#### **Power Source**

This product is intended to connect to a power source that will not apply more than 264 V RMS between the supply conductors or between either of the supply conductors and ground. A protective ground connection by way of the grounding conductor in the power cord is essential for safe operation.

Model 2732: Two Channel 50 MHz Function/Arbitrary Waveform Generator  
**Preparation for Use**

---



**Line Voltage & Fuse Selection:**

**CAUTION:** DO NOT APPLY POWER TO THE INSTRUMENT BEFORE READING THIS SECTION:

The Model 2732 is powered by a universal power supply. The 2732 design allows it to operate from 90 V to 264 V @ 47 Hz to 63 Hz. It is recommended that the fuse size be matched to the supply voltage before powering the unit.

First, determine the supply voltage that the instrument will be operating under and verify that the supply voltage does not fall outside of the allowable operating range (90 to 264 VAC). Then select the appropriate fuse size using the table below:

FUSE SIZE	
110/120 VAC	5 X 20 mm 1 A Slow Blow 250 V
220/240 VAC	5 X 20 mm 0.5 A 250 V

Make sure that the proper fuse size is installed. Use a slow blow fuse UL/CSA approved for 110 V operation and an IEC127 fuse for 220 V. The proper fuse types and ratings can be found on the rear panel.

The instrument is ready for power up. Proceed to "Quick Start Instructions" or "Operating Instructions" to continue with setup & operation.

INSTRUMENT DESCRIPTION  
PREPARATION FOR USE  
**QUICK START INSTRUCTIONS**  
OPERATING INSTRUCTIONS  
PROGRAMMING & INTERFACING  
SERVICE INFORMATION  
APPENDIX

Model 2732: Two Channel 50 MHz Function/Arbitrary Waveform Generator  
**Quick Start Instructions**

---



## Quick Start Instructions

---

### Introduction

The Model 2732 is a versatile product, which can be used in many different configurations. Virtually any wave type can be created and produced at the instrument's output. Because of its ability to operate as a function generator or arbitrary waveform generator it is highly recommended that the entire "Operating Instructions" Section of this manual be reviewed to insure the most efficient use of the instrument.

Generally speaking, function generator operation from the front panel or arbitrary wave creation using WaveWorks DDS are relatively simple procedures. These are described in this section along with practical examples. Arbitrary wave creation or editing from the instrument's front panel are more tedious tasks and are included in the "Operating Instructions" section only.

The Quick Start section is designed to give the user a general instruction set for the speedy setup and generation of common wave types. A reference is sometimes made to other parts of this manual so that the user, at their discretion, can decide whether or not to pursue additional information.

### Power the Unit

The universal power supply of Model 2732 is designed for 50-60 Hz operation and a voltage range of 90-264 VAC. It is assumed that the "Preparation for Use" section of this manual has been read and understood and the line voltage and fuse type has been verified to be correct.

Power the unit by depressing the pushbutton located on the lower left corner of the front panel. Verify that the unit will be operated in the operating environment as defined in the specifications.

### Your First Waveform

The 2732's intuitive design allows a waveform to be produced at the instrument's output with the stroke of a few keys. The example below demonstrates how to use the instrument as a standard function generator.

1. Power the unit and allow it to initialize.
2. Press the [CHAN] key to toggle between Channel 1 or Channel 2 parameters.
3. Press [WAVE] and select the desired waveform.
4. Press the [ON] key above the associated Output BNC connector: CH 1 or CH 2.
5. Observe the output waveform.
6. Press the [PARAM] key.
7. Turn the dial and adjust the output frequency.
8. Press F3:[AMPL] and adjust the amplitude.
9. Press F3:[OFST] again and adjust the offset voltage.
10. Verify the waveform's amplitude and offset with an oscilloscope. Use a 50  $\Omega$  termination at the scope's input.

Model 2732: Two Channel 50 MHz Function/Arbitrary Waveform Generator  
**Quick Start Instructions**

---

## Instrument Settings

### Factory Default Settings

It is important to know the instruments settings before attempting to use it. A good starting point is to return the instrument to its original factory settings. The factory default settings can be used for most general-purpose measurements.

The 2732 is shipped from the factory with the default settings summarized below:

**Table 3.1 – Factory Default Settings for Channel 1 and Channel 2**

Key Function	Setting	Comments
FREQUENCY	1 kHz	Wave frequency
RATE(ARB)	1 $\mu$ s	Sample time per point
AMPLITUDE	5.00 V	Peak to peak output amplitude
FUNCTION	SINE	Output waveform
OFFSET	0.00 V	Zero offset
REPETITION	10 ms	External trigger rate
MODE	CONT	Waveform mode
N-BURST	2	Waves per burst
START ADRS	1	Start memory address
WAVELENGTH	1000	Number of points per waveform
TRIG SOURCE	EXT	External trigger source
OUTPUT	OFF	Output disabled
SWEEP	OFF	Sweep execution
MODULATION	OFF	Modulation execution

Restoration to factory settings restores the parameters from Table 3.1 on both channels of the 2732 simultaneously.

You may restore the factory default settings at any time by recalling memory location 0.  
Press [SETUPS]>[RECALL]>[0]>[ENTER]

NOTE: When the unit is reset to factory defaults, user-defined, non-volatile wave data is retained.

## Quick Start Instructions

---

### Using the Function Generator

#### Changing Channels:

Channel selection is performed by pressing the [CHAN] button, this key toggles between Channel 1 and Channel 2. Channel settings are independent and stay in memory while changing channels

#### Parameter Key

[PARAM] – Once the desired wave function is selected, pressing this key displays the basic function or arbitrary waveform parameters, which include frequency, amplitude, offset and int/ext reference clock mode. The parameters may be modified by accessing the soft keys on the bottom of the display. The active parameters are highlighted in black. In the Arbitrary Waveform mode, the sampling rate can also be viewed or modified.

Enter new parameter values by:

- Typing in a numeric value and then pressing [ENTER].
- For immediate changes at the instrument's output, adjust the rotary dial in combination with use of the left and right arrow keys.

#### Waveform Key

[WAVE] – Pressing this key displays the wave menu. You can choose from sine, square, triangle (ramp), pulse, or arbitrary wave types by pressing [F1]:SINE, [F2]:SQR, [F3]:TRI, [F4]:PULSE OR [F5]:ARB. The active wave type is highlighted in black. Pressing the soft key will enable the respective wave type. Pressing the [ON] key located above channel 1 or Channel 2 will either enable or disable the main output on each respective channel. The output status is indicated on the upper right hand corner of the LCD by a **CH1** or **CH2** indicator. A darkened channel status is defined as an active output channel.

#### Trigger Menu

[MODE] - Access the trigger menu by pressing this key. There are five options available from the trigger menu. These are:

- |            |  |
|------------|--|
| [F1]:CONT  | Enables the continuous triggering mode.  |
| [F2]:TRIG  | Chooses either a manual, internal or external trigger source.  |
| [F3]:GATE  | Allows the output to be gated via manual, internal, or external trigger.   |
| [F4]:BURST | Allows the number of bursts (2-999,999) to be programmed and chooses manual, internal or external triggered burst. |
| [F5]:PHASE | Allows a non-continuous triggered waveform to start at the specified phase.  |

#### Sweep Menu

[SWEEP] - There is no sweep function for the arbitrary waveform mode. Enable the sweep function by pressing this key and then enter the required parameters for the sweep function. The user defines the start and stop addresses and the rate at which one complete sweep occurs. A linear or logarithmic sweep may be specified.

## Quick Start Instructions

---

### Using the Function Generator cont'd:

#### Modulation

[MODUL] - Press this key to access the modulation menu. **For arbitrary waveforms, only AM modulation is available.** For function generator waveforms, AM, FM, and FSK are available.

- |          |  |
|----------|--|
| [F1]:AM  | Chooses amplitude modulation and allows the user to define % modulation, modulation shape, and the frequency of modulation.              |
| [F3]:FM  | Accesses the frequency modulation menu, which allows selection of deviation frequency, modulation shape, and the modulation frequency.   |
| [F5]:FSK | Accesses the frequency shift keying menu where low and high frequencies and the rate of change between these frequencies may be defined. |

#### Setups

[SETUPS] - Up to 49 (from 1 to 49) system setups may be stored in the 2732. Location zero is reserved for factory defaults and location 50 is reserved for the last settings before the unit was powered down. Simply choose to recall or to store a memory location by pressing the [F1]:RECALL OR [F3]:STORE keys, entering which location to read or write to, and then pressing [ENTER] to activate or save the specified settings.

\*When a setup is stored, Channel 1 and Channel 2 settings are stored simultaneously into a single memory location.

#### Utility

[UTIL] - Press this key to access the utility menu. The utility menu allows the user to:

- |            |  |
|------------|--|
| [F1]:GPIB  | Selects the GPIB address of the 2732 and enables GPIB operation. |
| [F2]:RS232 | Sets the RS232 baud rate and enables RS-232C operation.          |
| [F3]:INTEN | Sets the LCD intensity.  |
| [F4]:POWER | Defines which stored setup will resume on every power up.        |

### **Downloading a Waveform from WaveWorks DDS to the Instrument**

- 1) Start WaveWorks DDS by double-clicking the icon.
- 2) Select the instrument model number by pressing File>Instruments>Model 2732.
- 3) Create the desired waveform by using the tools in WaveWorks DDS or importing a \*.txt data file.
- 4) Connect the supplied serial cable between the Model 2732 and the serial port on your computer.
- 5) Define the RS-232 settings in WaveWorks DDS by pressing Communication>Send Waveform>RS-232.
  - a. Set the channel to either Channel 1 or Channel 2.
  - b. Define the start and length of the waveform data.
  - c. Set the port number and baud rate. (use 19200 for this example)
- 6) On the 2732, press [UTIL]>[RS-232], set the baud to 19200 and press [ENTER]. Confirm that the 2732 instrument settings match WaveWorks settings.
- 7) Press the send button in the WaveWorks DDS "Send Waveform" screen.
- 8) The wave data created by WaveWorks DDS will download to the arb.

## Quick Start Instructions

---

### Using WaveWorks DDS to Create an Arbitrary Waveform

WaveWorks DDS is a basic wave creation tool offered as a standard accessory for TEGAM models 2720, 2725, 2730, and 2732 function/arbitrary waveform generators. With WaveWorks DDS, the user has the ability to create, modify and download a customized waveform using up to 9 standard waveform templates, a freehand drawing tool, insert function and other editing tools. For more information on WaveWorks DDS and other advanced arbitrary waveform creation and editing software, contact your local TEGAM sales office.

The example below demonstrates the basic use of WaveWorks DDS software. Designed specifically for TEGAM's DDS based function/arbitrary generators, WaveWorks DDS eliminates the need for front panel wave editing, which can be tedious and time consuming. The exercise below demonstrates the creation of a 1 kHz, sine wave burst of 3 complete cycles. The frequency of the entire arbitrary waveform (including the three sine bursts) is 200 Hz.

#### Build the Waveform

1. Start WaveWorks DDS
2. Press File>Instruments>Model 2732
3. Click on INSERT>SINE...
4. Select Start Point = 1, Length = 1000, Scale = 0.50, Offset = 0.00
5. Click on INSERT>SINE
6. Select Start Point = 1001, Length = 1000, Scale = 0.50, Offset = 0.00
7. Click on INSERT>SINE
8. Select Start Point = 2001, Length = 1000, Scale = 0.50, Offset = 0.00
9. Click on INSERT>DC
10. Select Start Point = 3001, Length = 2000, Scale = N/A, Offset = 0.00
11. Click on COMMUNICATION>SEND WAVEFORM>RS232  
NOTE: Be sure to use the proper RS-232 communications cable type  
Select Channel 1, Start Point = 1, Length = 5000
12. Select PORT = COM1, Baud Rate = 19200 (make sure the instrument is set for 19,200)
13. Apply power to 2732
14. On the 2732, press [UTIL]>[F2]:RS232, set Baud = 19200 using rotary knob
15. Click "Send" In the WaveWorks DDS window.
16. Wave data will be transmitted to the Model 2732. The message "Remotely Controlled - RS232" will be displayed on the Model 2732's display.

#### Display of the Waveform on an Oscilloscope:

Channel 1 on the 2732 will output the created wave as it is being downloaded to an attached oscilloscope via a standard BNC connected cable. Once downloading is complete, control will be returned to the instrument's front panel and the wave in it's entirety will be displayed.

## Quick Start Instructions

---

### General Tips for Usage

#### Connecting to the Main Output

Use a good quality BNC cable to connect to the main output. Verify that the load impedance is 50Ω. Load impedances higher than 50Ω will result in higher output magnitudes and reflections in the output at high frequencies. Impedances lower than 50Ω will result in lower output magnitudes than programmed in the instrument.

#### Function Generator Operation

Operating the 2732 as a function generator is best performed using the instrument's front panel. Pressing the [PARAM] key allows user definable access to waveform parameters.

#### Arbitrary Wave Creation

Arbitrary wave creation can be performed by using the 2732 front panel keys or with WaveWorks DDS software. The frequency of an arbitrary waveform is determined by dividing the sample rate by the number of samples used for one cycle. The output amplitude is determined by the percentage of full scale of the arbitrary wave times the programmed amplitude of the output.

See the example in section 4 titled, "Setting the Frequency" for more details.

#### Waveform and Execution Memory

The waveform generator uses two forms of memory. These are Dynamic RAM for defining, editing and generating arbitrary waveforms and non-volatile flash memory for storing arbitrary waveform data and front panel settings when the instrument is off. Both dynamic RAM and non-volatile flash memories consist of 4,000,000 points per channel at which you can specify a value from -8192 to +8192. You can scale these points through the output amplitude setting; that is, data point 8192 is equal to the positive peak (Scale = 1.0) of the user-defined output amplitude.

#### Additional Examples

Examples for creating and editing arbitrary waveforms are located in the "Operating Instructions" section of this manual.

Model 2732: Two Channel 50 MHz Function/Arbitrary Waveform Generator  
**Quick Start Instructions**

---



INSTRUMENT DESCRIPTION  
PREPARATION FOR USE  
QUICK START INSTRUCTIONS  
**OPERATING INSTRUCTIONS**  
PROGRAMMING & INTERFACING  
SERVICE INFORMATION  
APPENDIX

Model 2732: Two Channel 50 MHz Function/Arbitrary Waveform Generator  
**Operating Instructions**

---

Model 2732: Two Channel 50 MHz Function/Arbitrary Waveform Generator  
**Operating Instructions**

---

### General Description

This section describes the displays, controls and connectors of the TEGAM Model 2732 Function/Arbitrary Waveform Generator. All inputs, outputs, and instrument controls are located on the front or rear panels.

### Front Panel

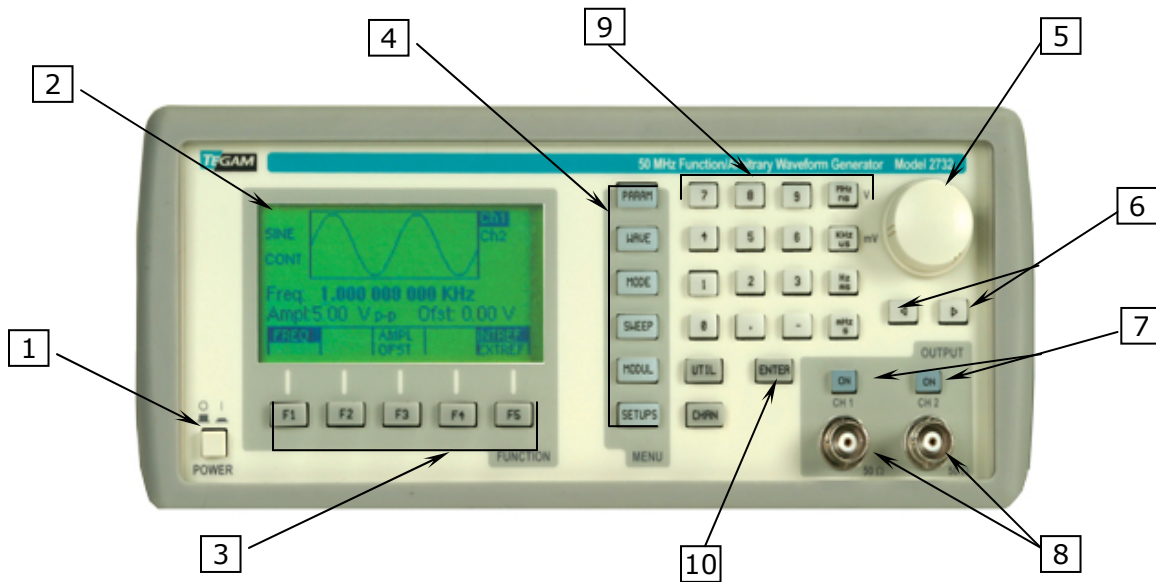

**Figure 4.1 - Model 2732 Front Panel**

- |                    |  |
|--------------------|--|
| 1. ON/OFF Switch   | Applies and removes AC power to the unit.  |
| 2. LCD Window      | Displays all instrument data and settings.   |
| 3. [F1]-[F5] Keys  | Selects the soft key menu options that appear on the second line of the LCD display. Menus differ depending on the selected parameter, function or mode. |
| 4. MENU Keys       | Select parameters, functions or modes whose settings are to be displayed or changed.   |
| 5. Rotary Knob     | Used to increment/decrement numerical values or to navigate through the possible selections.   |
| 6. Cursor Keys     | Used to move the cursor (when visible) to either left or right for parameter and data selection.   |
| 7. Output ON       | Enables/disables Channel 1 and 2 output signal. The output status is displayed on the top right corner of the LCD.                                       |
| 8. BNC Outputs     | Channel 1 and Channel 2 waveform output connectors.  |
| 9. Data entry Keys | For numeric and units entry of waveform parameter data.  |
| 10. [ENTER] key    | Activates the current parameter or selection.  |

Model 2732: Two Channel 50 MHz Function/Arbitrary Waveform Generator  
**Operating Instructions**

---

### Display Window

The Model 2732 has a graphic LCD display that can display 160x80 dots. When you power the unit, a parameter (Frequency) and its current settings appear in the display. There is also a graphical representation of the current waveform on the LCD. A soft key menu is located on the bottom of the LCD that corresponds to the function, parameter or mode selected.

### Front Panel Controls

The front-panel controls select, display, and change parameter, function, and mode settings. They also include the keys used to program and generate a waveform output. Use the rotary input knob and the cursor movement keys to enter data into the waveform generator.

To change a setting:

1. Press the appropriate function/parameter/mode key.
2. Use the [◀] [▶] keys to adjust the cursor position
3. Use the rotary input or the numerical/units keyboard to change the value of the displayed item. Changes take effect immediately, or after the [ENTER] or units keys are pressed.

### Front Panel Output Connectors

The 2732 function/arbitrary generator has two BNC connectors on the front panel, CH 1 and CH 2 OUTPUT.

#### Channel 1 Output Connector

Use this connector to transfer the Channel 1 output signal from the function generator to a compatible (50  $\Omega$ ) load. Use the CH 1 [ON] key to enable or disable the output. An annunciator, **Ch 1** appears in the upper right hand corner of the LCD when the output for Channel 1 is enabled.

#### Channel 2 Output Connector

Use this connector to transfer the Channel 2 output signal from the function generator to a compatible (50  $\Omega$ ) load. Use the CH 2 [ON] key to enable or disable the output. An annunciator, **Ch 2** appears in the upper right hand corner of the LCD when the output for Channel 2 is enabled.

Model 2732: Two Channel 50 MHz Function/Arbitrary Waveform Generator  
**Operating Instructions**

---

**Rear Panel**

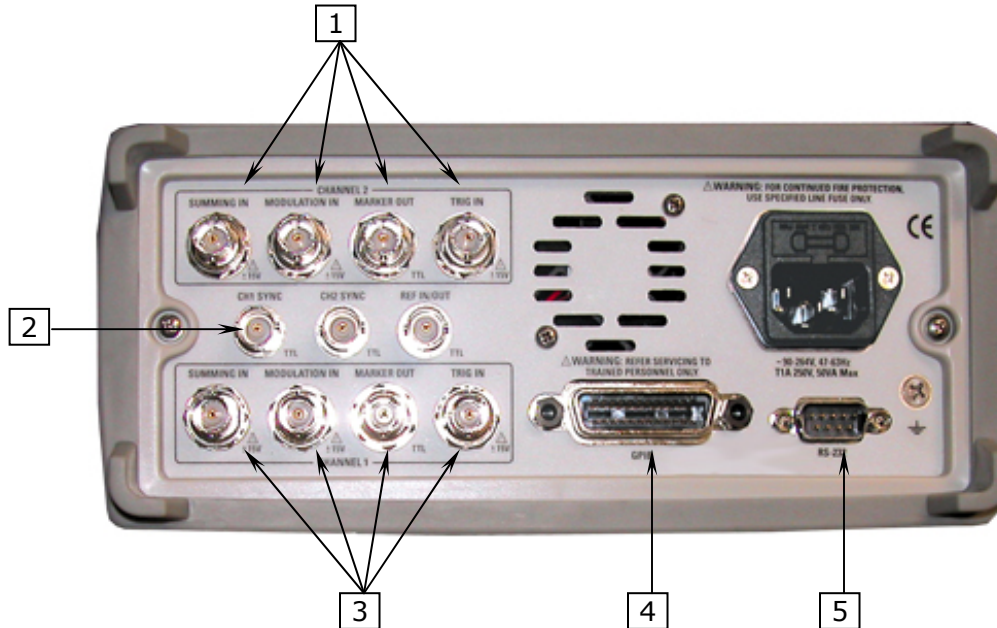

**Figure 4.2 - Model 2732 Rear Panel**

1. Channel 2 BNC's      Summing Input, Modulation Input, Marker Output, Trigger Input Connectors.
2. Channel 1 and 2      Synchronous TTL Output and Reference In/Out Connectors.
3. Channel 1 BNC's      Summing Input, Modulation Input, Marker Output, Trigger Input Connectors.
4. GPIB                    IEEE-488.2 Bus Interface connector.
5. RS-232                 RS-232 communications connector

### **Rear Panel Input Connectors**

The 2732 rear panel has seven input BNC connectors. Channel 1 and channel 2 have independent SUMMING IN, MODULATION IN, and TRIG IN, The 2732 shares a common REF IN/OUT.

#### Summing In Connectors (2)

Use these connectors to apply an external analog signal that will be added to the output waveform. A 5 Vp-p signal is required for full-scale output. The input impedance is 500  $\Omega$ .

#### Modulation In Connectors (2)

Can accept a 5 Vp-p signal for 100% modulation, 10 k $\Omega$  input impedance with DC-20 kHz minimum bandwidth.

#### Trigger In Connectors (2)

Use these connectors to apply positive external TTL triggers or gate signals, depending on the waveform generators settings, to the generator.

#### Ref In/Out Connector

When the 2732 is in "External Reference Mode", this connector is used as an input from an externally generated 10 MHz signal. In the "Internal Reference Mode", the input becomes a 10 MHz output.

### **Rear Panel Output Connectors**

The rear panel has five output BNC connectors, (2) MARKER OUT, (1) REF OUT, and (2) SYNC OUT.

#### Marker Output Connectors (2)

These connectors output a positive TTL marker pulse when the 2732 is in arbitrary waveform mode. The marker position and width can be programmed by the user and is relative to the data points in the arbitrary waveform memory. The output is disabled when the 2732 is in function generator mode or when an inactive address is defined. There is a separate marker output for both channel 1 and channel 2.

#### Ref In/Out Connector

When the 2732 is in "External Reference Mode", this connector is used as an input for an externally generated 10 MHz signal. In the "Internal Reference Mode", the input becomes a 10 MHz output.

#### Sync Out Connectors

These outputs provide positive TTL sync pulses, which are generated at the beginning of each function generator or arbitrary waveform cycle. Its duration is the period of the output waveform at a 50% duty cycle. Parameters other than the frequency/period are fixed. Each channel has it's own unique synchronization output.

Model 2732: Two Channel 50 MHz Function/Arbitrary Waveform Generator  
**Operating Instructions**

---

**NOTE:** Channel 1 and 2 settings are independent of one another and can be changed by using the [CHAN] key.

**MENU Keys**

These keys select the main menus for displaying or changing a parameter, function or mode.

**Figure 4.3 - [PARAM] - PARAMeter Menu Tree**

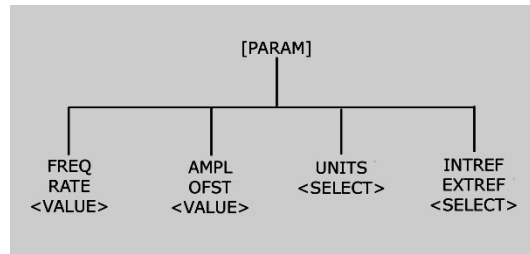

**[PARAM] - PARAMeter Menu**

Pressing this key displays the basic function or arbitrary waveform data, which includes frequency, amplitude/offset and int/ext reference clock mode. These parameters may be modified by accessing the soft keys on the bottom of the display. Active settings are highlighted in black and parameter values may be entered via the keypad and/or the dial. In the Arbitrary Waveform mode, the sampling rate can also be viewed or modified.

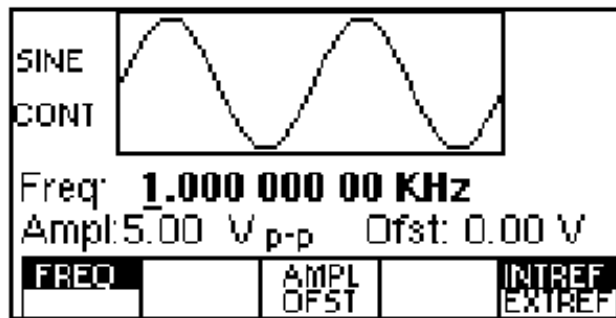

*Frequency Menu*

**[F1]:FREQ**

Selects and displays the frequency. Change the frequency setting by using the cursor keys, rotary dial or numeric/units keys. If a certain setting cannot be produced, the waveform generator displays an "Out of Range" or other error message.

**[F1]:FREQ/RATE**

(for Arbitrary Waveform mode only). Selects and displays the point execution rate or frequency. The rate governs the speed at which waveform points are executed, and thus directly affects the output frequency of the waveform. When you set this parameter, the waveform generator will keep that execution rate for all waveform lengths until it is changed.

**MENU Keys cont'd:**

**[PARAM] - PARAMeter Menu cont'd:**

**[F3]:AMPL/OFST** This key toggles between the Amplitude and Offset Settings.

**AMPL** When AMPL is highlighted, the amplitude parameter is selected. Change the amplitude setting by using the cursor keys, rotary dial or numerical keys. If a certain setting cannot be produced, the waveform generator will display an "Out of Range" or other error message.

The default amplitude is displayed in p-p voltage. However, once the AMPL function is active the user may select from Vp-p, Vrms, or dBm units by pressing the [F4]:UNITS key.

Setting the Amplitude

The following equation represents the relative output voltage amplitude relationship between the front-panel amplitude peak-to-peak setting and the data point values in waveform memory:

$$\text{Output voltage} = \frac{\text{amplitude p-p setting} \times \text{data point value}}{16,383} + \text{offset}$$

Where 16,383 is the data point value range in waveform memory.

**Table 4.1: Waveform Amplitudes (Examples)**

Front Panel Amplitude Setting	Data Point Value	Relative Output Voltage Amplitude
5 Vp-p	8191	+2.5 V
5 Vp-p	4096	+1.25 V
5 Vp-p	0	0V (offset voltage)
9 Vp-p	1200	659 mV
9 Vp-p	-4000	-2.197 V
4 Vp-p	-8191	-2.0 V



**MENU Keys cont'd:**

**[PARAM] - PARAMeter Menu cont'd:**

**[F3]:AMPL/OFST** This key toggles between the Amplitude and Offset Settings.

**OFST** When OFST is highlighted, the Offset parameter is active. Change the offset by using the cursor keys, rotary dial or numerical keys. If a certain setting cannot be produced, the waveform generator will display a "Setting Conflict" message.

Amplitude and Offset Interaction:

Amplitude and offset settings interact and are bound by hardware restrictions. In order to obtain the desired waveform the following amplitude and offset hardware limitations must be considered:

The offset voltage has three ranges as follows:

**Table 4.2 – Voltage Offset Ranges**

<b>Output Voltage Range</b>	<b>Constraints of Amplitude + Offset</b>
0.010 volt to 10.00 volts	$(V_{p-p})/2 +  \text{offset}  \leq 5 \text{ volts}$

**MENU Keys cont'd:**

**[PARAM]** - *PARAMeter Menu cont'd:*

**[F4]:UNITS** This soft key is only visible after the [F3]: AMPL/OFST key has been pressed and AMPL is highlighted. Press [F4]: UNITS to toggle between: V p-p, V rms, or dBm as the primary units for Amplitude and Offset values.

**[F5]:INT/EXT REF** Selects the internal or external clock reference source (the external reference must be connected to the rear panel Ref In/Out connector). Pressing the [F5] key will toggle between the two reference options.

Model 2732: Two Channel 50 MHz Function/Arbitrary Waveform Generator  
**Operating Instructions**

**MENU Keys cont'd:**

**Figure 4.4 - [WAVE] - WAVE Menu Tree**

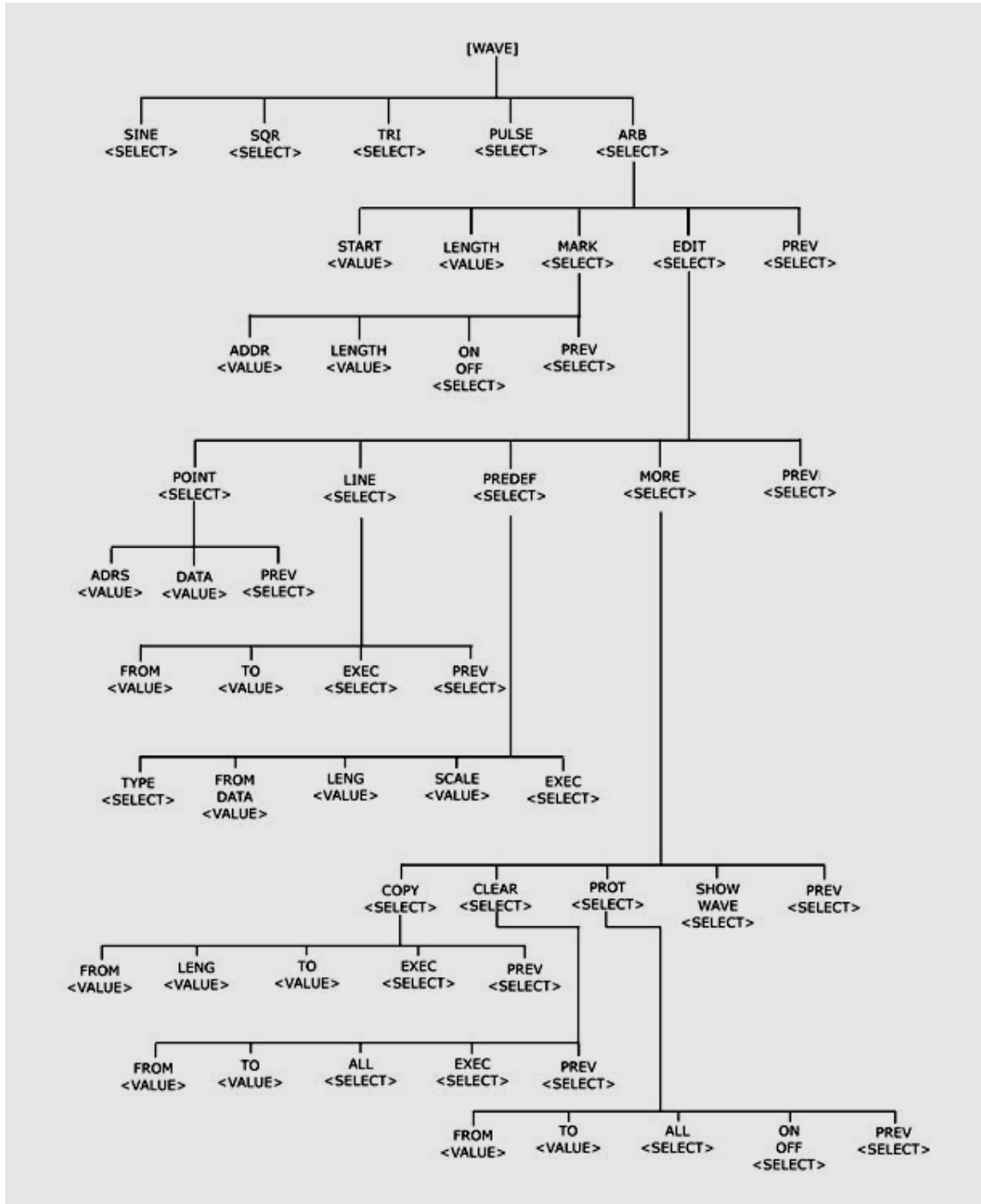

Model 2732: Two Channel 50 MHz Function/Arbitrary Waveform Generator  
**Operating Instructions**

---

**MENU Keys cont'd:**

**[WAVE] - WAVE Menu cont'd:**  
Displays the waveforms available:

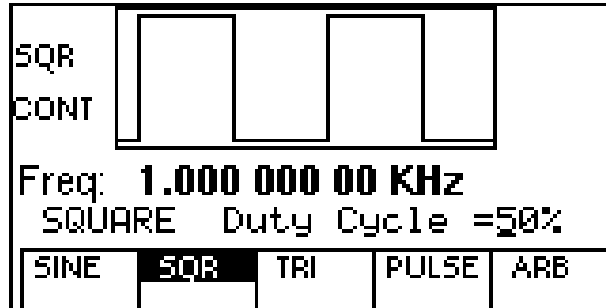

**Waveform Menu**

- [F1]: SINE** Selects the sine waveform.
- [F2]: SQR** Selects the square waveform and allows the waveform duty cycle to be changed from 20% to 80% (up to 5 MHz) and 40% to 60% (5 to 20 MHz). Frequencies from 20 MHz to 50 MHz are automatically set to 50% duty.
- [F3]: TRI** Selects the triangle waveform and displays the waveform symmetry that can be changed from 10% to 90%. The triangle maximum frequency is 500 kHz.
- [F4]: PULSE** Selects the pulse waveform and allows for parameter definition.  
NOTE: The pulse parameters are interrelated therefore setting one parameter may limit the range of another parameter. For example setting the frequency or period will limit the maximum allowable pulse width. Below is a summary of constraints for defining a pulse:
- Width < Period  
Width ≥ Period \* 1 E-6  
Width ≥ (Rise+Fall)
- Period > Width + (Rise + Fall)  
Rise ≥ Width / 100 (or Rise = .01 μs)  
Fall ≥ Width / 100 (or Fall = .01 μs)
- Rise > Period / 100,000 (or Rise = .01 μs)  
Fall > Period / 100,000 (or Fall = .01 μs)

**MENU Keys cont'd:**

[WAVE] - *WAVE Menu cont'd:*

[F4]: **PULSE cont'd**

The parameters (period, width, rise & fall) of the pulse waveform should agree with the previously defined constraints. Refer to the illustrations below for details on the definition of rise, fall, width and period.

**Figure 4.5 – Definition of 10-90% Rise and Fall**

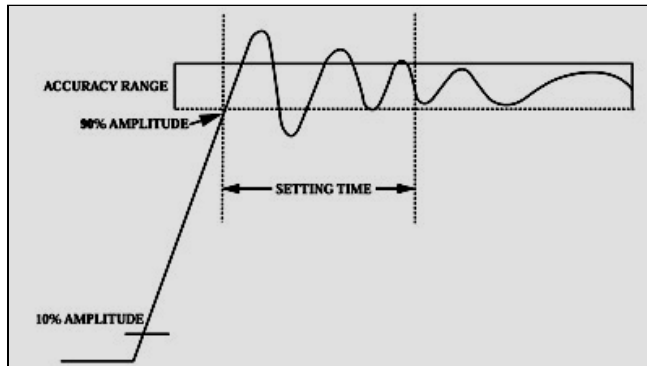

**Figure 4.6 – Definition of Width, Leading and Trailing Edges**

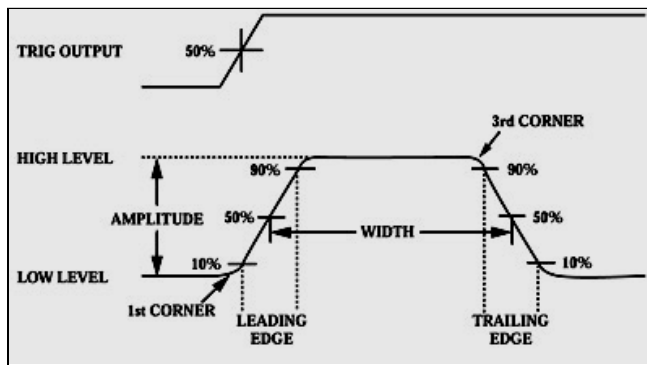

**MENU Keys cont'd:**

**[WAVE]** - *WAVE Menu cont'd:*

**[F4]: PULSE cont'd**

**[F1]:FREQ/PERIOD**

Allows the frequency or the period of the pulse waveform to be defined. The pulse frequency ranges from 500  $\mu$ Hz to 25 MHz (2000 S to 40 nS). The frequency/period limits may be restricted by the width, lead, and trail settings. If the frequency is set then the period is automatically adjusted to 1/f. If the period is set then the frequency is automatically adjusted to 1/P.

**[F2]:WIDTH**

This sets the width of the pulse on time. The minimum allowable width is 20 nS. (This allows time for a 10 nS lead and trail edge time). The maximum allowable pulse width is 1999 S.

**[F3]:EQUAL/EDGE**

Sets both the leading and trailing edge of the pulse to this transition time.

**[F4]:LEAD/TRAIL**

This allows the leading and trailing edge of the pulse to be programmed with different values.

**[F5]:PREV**

Returns to the previous menu.

An example for defining and creating a pulse is at the end of the Operating Instructions section.

Model 2732: Two Channel 50 MHz Function/Arbitrary Waveform Generator  
**Operating Instructions**

---

**MENU Keys cont'd:**

[WAVE] - *WAVE Menu cont'd:*

[F5]: **ARB**           Selects the arbitrary waveform and then displays the arbitrary menu:

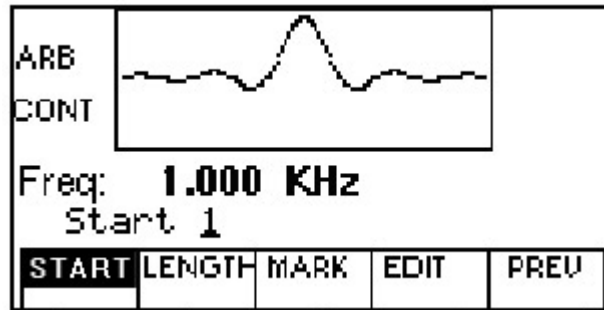

Arbitrary Menu

**MENU Keys cont'd:**

**[WAVE] - WAVE Menu cont'd:**

**Arbitrary Waveform Menu:**

**[F1]: START** Start Location - Selects the arbitrary waveform start address. Minimum value =1. The start address must have an odd value.

**[F2]: LENGTH** Waveform Length - Selects the arbitrary waveform length. Use the START and LENGTH keys to mark a selection of waveform memory that will be executed. The length must have an even value.

**[F3]: MARK** Marker Output - Accesses the menu for defining the start address and width of the TTL marker pulse available at the Marker Out connector. The Marker pulse can be programmed at any width or location within the start and stop addresses of the arbitrary waveform.

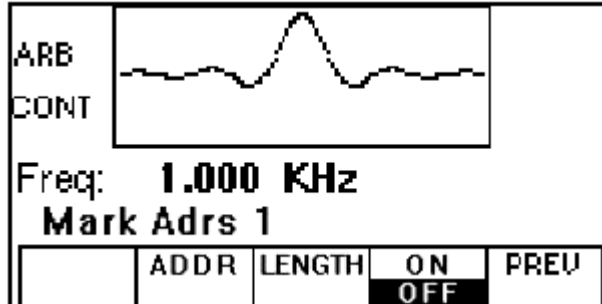

**Marker Output Menu**

- [F2]:ADDR** - Marker begins at the specified address.
- [F3]:LENGTH** - Allows the marker width to be defined.
- [F4]:ON/OFF** - Enables or disables the marker.
- [F5]:PREV** - Returns to the previous menu.

Note: Changing one of the arbitrary parameters such as start, length or marker causes immediate updating of the output waveform to the new parameter settings.



Model 2732: Two Channel 50 MHz Function/Arbitrary Waveform Generator  
**Operating Instructions**

---

**MENU Keys cont'd:**

[WAVE] - *WAVE Menu cont'd:*

**Arbitrary Waveform Menu**

**[F4]: EDIT Menu** Enters data for creating arbitrary waveforms. You can enter data one point at a time, as a value at an address, draw a line from one point (a value at an address) to another point, create a predefined waveform, or combine these to create complex waveforms. The valid amplitude data values range from -8091 to 8091. The valid waveform memory addresses range from 1 to 4,000,000.

The data value governs the output amplitude of that point of the waveform, scaled to the instrument's output amplitude. Therefore, a value of 8091 corresponds to positive peak amplitude, 0 corresponds to the waveform offset, and -8191 corresponds to the negative peak amplitude.

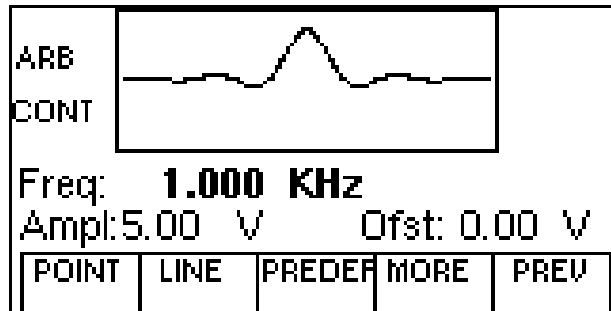

Arbitrary Waveform Edit Menu

**[F1]: POINT**

This menu allows for point-by-point waveform editing. When selected, the following menu is displayed:

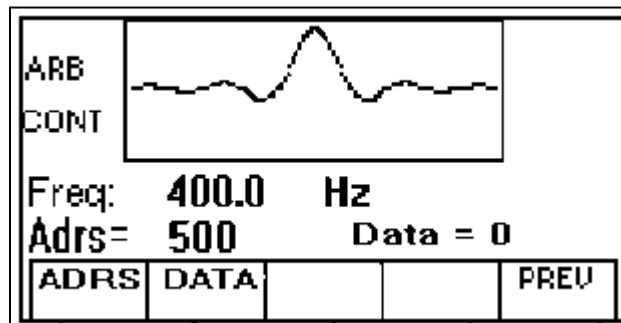

Arbitrary Waveform>Edit>Point Menu

Model 2732: Two Channel 50 MHz Function/Arbitrary Waveform Generator  
**Operating Instructions**

---

**MENU Keys cont'd:**

[WAVE] - *WAVE Menu cont'd:*

**Arbitrary Waveform Edit Menu**

- [F1]:ADDR - Selects the current address in the arbitrary waveform memory.  
[F2]:DATA - Selects the data point value at the current address from -8191 to 8191.

[F2]: LINE This menu allows a line drawing between two selected points. Displays the following menu:

- [F1]: FROM Selects the starting point address.  
[F2]: TO Selects the ending point address.  
[F4]: EXEC Displays the Confirmation menu:  
[F1]:NO  
[F3]:YES

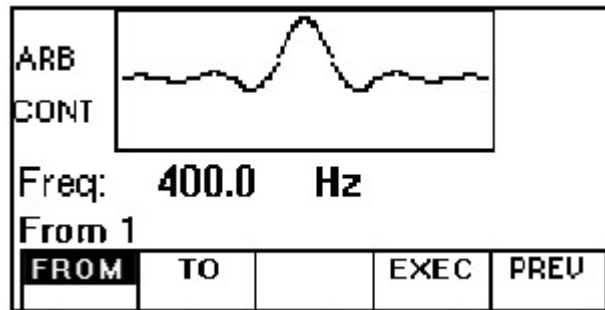

Arbitrary Waveform>Edit>Line Menu

**MENU Keys cont'd:**

[WAVE] - *WAVE Menu cont'd:*

**Arbitrary Waveform Edit Menu**

[F3]: **PREDEF**      Selects one of the predefined waveforms: Sine, Triangle, Square, Noise, Ramp Up, Ramp Down, Sin(x)/x, Exponent Up, Exponent Down, and Gaussian.

Displays the predefined waveforms menu:

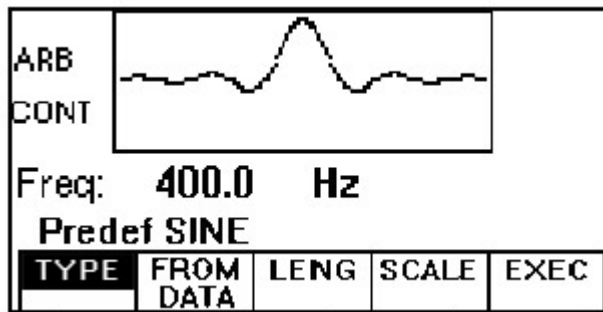

**Arbitrary Waveform>Edit>Predefined Waveform Menu**

[F1]: **TYPE**  
 Selects a Sine, Triangle, Square, Noise, Ramp Up, Ramp Down, Sin(x)/x, Exponent Up, Exponent Down, or Gaussian waveform. If the Noise function is selected (by pressing [EXEC]), a submenu is displayed. See [F4]:EXEC for more details.

- [F1]: **ADD**      - Allows the noise to be added to existing waveform data.
- [F3]: **NEW**      - Generate noise waveform/data to be used as a new waveform.
- [F4]: **EXEC**     - Execute the wave generation.
- [F5]: **PREV**    - Return to the previous menu.

[F2]: **FROM DATA**  
 Selects the starting point of the generated waveform and data value.

Model 2732: Two Channel 50 MHz Function/Arbitrary Waveform Generator  
**Operating Instructions**

---

**MENU Keys cont'd:**

**[WAVE] - WAVE Menu cont'd:**

**Arbitrary Waveform Edit Menu**

**[F3]: LENG**

Selects the length of the predefined waveform (number of points for a full wave). Different waveforms have different limitations on length, as shown in Table 4-3. The maximum allowable length for a predefined waveform is 65,536 points.

**Table 4-3: Length Limits for Predefined Waveforms**

Wave	Minimum length	Divisible by
Sine	16	4
Triangle	16	4
Square	2	2
Noise	16	1

**[F4]: SCALE**

Selects the scale factor of the waveform. 100% means that the waveform spans the full scale of -8191 to 8191. Scale factors are limited by the point data value of the starting point and automatically calculated by the unit.

**[F5]: EXEC**

Prompts you to confirm whether to execute the selected predefined waveform. Press [F1]:NO to abort executing the predefined waveform; Press [F3]:YES to execute the predefined waveform.

On the NOISE function a menu of [F1]:ADD and [F3]:NEW prompts the user to save the noise data as a new waveform or to add the noise data to the existing wave data in the specified data range.

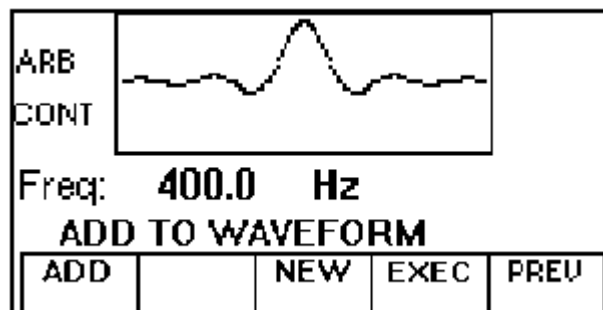

**Arbitrary Waveform>Edit>Predefined>Type>Noise>Exec Menu**

**MENU Keys cont'd:**

[WAVE] - *WAVE Menu cont'd:*

**Arbitrary Waveform Edit Menu**

[F4]: MORE            Displays more editing functions, as shown:

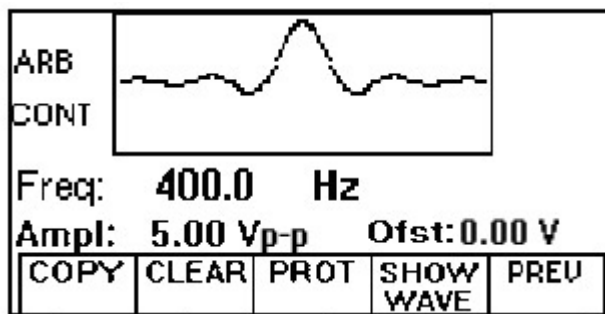

**Arbitrary Waveform>Edit>More Menu**

[F1]: COPY            Displays the Copy menu so that an area of waveform memory may be identified, copied and then written to another location in waveform memory.

[F1]:FROM  
Selects the address of the first point to copy.

[F2]:LENG  
Selects the length (number of points) of the waveform to copy.

[F3]:TO  
Marks the destination address where the first point and subsequent points are pasted.

[F4]:EXEC  
Prompts you to confirm whether to copy. Press [F1]:NO to abort copying [F3]:YES to copy.

[F5]:PREV  
Returns to previous menu.

**MENU Keys cont'd:**

**[WAVE] - WAVE Menu cont'd:**

**Arbitrary Waveform Edit Menu**

**[F2]: CLEAR**

Displays the Clear menu so that either a section of or all of waveform memory may be reset to zero data values.

[F1]:FROM

Selects the address of the first point to clear.

[F2]:TO

Selects the address of the last point to clear.

[F3]:ALL

Clears the whole waveform memory. Equivalent to selecting from 1 to 4,000,000.

[F4]:EXEC

Prompts you to confirm whether to clear. Press [F1]:NO to abort clearing, and [F3]:YES to clear the specified range of data.

[F5]:PREV

Returns to previous menu.

**[F3]: PROT**

Displays the Protect menu so that a section of waveform memory may be protected and made into ROM.

[F1]:FROM

Selects the starting address of the data to protect.

[F2]:TO

Selects the ending address of the data to protect.

[F3]:ALL

Protects the whole waveform memory. Equivalent to selecting from 1 to 4,000,000.

*NOTE: you can protect only one segment of waveform memory at a time.*

[F4]: ON/OFF

Enables or disables memory protection.

[F5]:PREV

Returns to previous menu.

**MENU Keys cont'd:**

**[WAVE]** - *WAVE Menu cont'd:*

**Arbitrary Waveform Edit Menu**

**[F4]:SHOW WAVE** Uses the entire LCD area to graphically display the active waveform. Pressing the [F4]:SHOW WAVE again or any other key will return the LCD to its normal state.

**[F5]:PREV** Returns to previous menu.

MENU Keys cont'd:

Figure 4.8 - [MODE] - Trigger *MODE* Menu Tree

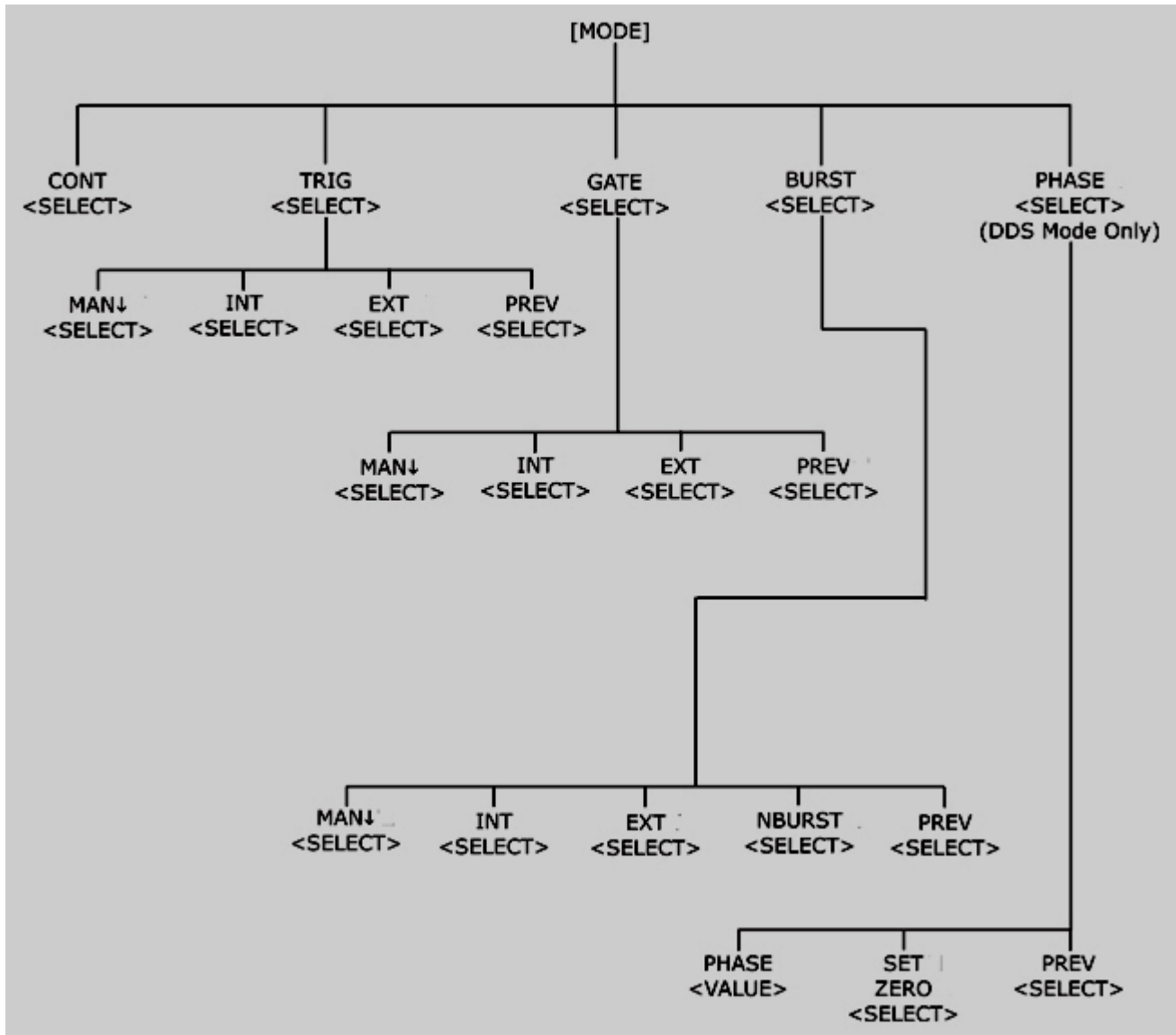



## MENU Keys cont'd:

### [MODE] - Trigger *MODE Menu*

Selects the output mode: CONT (Continuous), TRIG (Triggered), GATE (Gated), BURST (Burst) and PHASE (Phase Offset Mode). In TRIG or BURST modes, the address counter always stops at the last data point of the waveform. The value of the last data point is held at the output until another trigger is received.

To select the output mode, press MODE, then press the function *key* that corresponds to the desired Mode menu option, as shown:

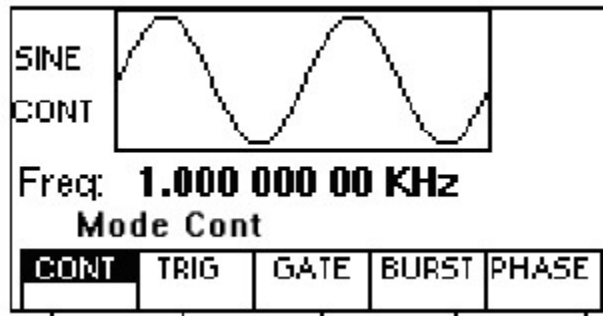

Trigger Mode Menu

- [F1]: **CONT**      Selects continuous trigger mode. The waveform is repeated indefinitely.
- [F2]: **TRIG**      Selects trigger mode where one output cycle of the selected waveform executes for each trigger event. See the next section for a description of sub menu.
- [F3]: **GATE**      The Gated Mode triggers output cycles as long as the trigger source asserts the gate signal. See the next section for a description of sub menu.
- [F4]: **BRST**      The Burst triggers the output N output cycles for each trigger event, where N ranges from 2 to 999,999. See the next section for a description of sub menu.
- [F5]: **PHASE**      Phase – Selects the start phase of the signal in non-continuous modes. This function is available for Sine, Square, Pulse and Triangle, DDS wave types and not for arbitrary waveforms. Pressing [F1]:PHASE, allows a value from  $-360^{\circ}$  to  $+360^{\circ}$ , with a  $.1^{\circ}$  resolution to be entered. [F2]:SET-ZERO, resets the phase value to zero.

Model 2732: Two Channel 50 MHz Function/Arbitrary Waveform Generator  
**Operating Instructions**

---

**MENU Keys cont'd:**

[MODE] - Trigger *MODE Menu cont'd:*

**Trigger Source Mode Menu (For TRIG, GATE or BURST modes)**

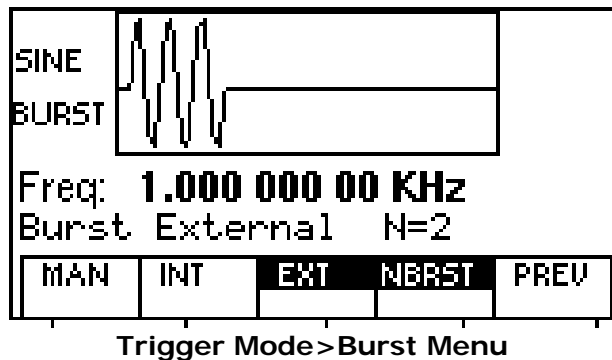

**[F1]: MAN**

Pressing this key once will cause a "MAN ↓" to appear denoting that manual trigger has been selected. Pressing the key again will trigger the output once. In burst mode, the active wave will be repeated "N" times at the output every time this key is pressed.

**[F2]: INT**

Selects the internal trigger generator as the trigger source. Change the internal trigger rate with the rotary input knob, numeric keys or the units keys. The rate determines the time interval between internal trigger pulses.

For Burst mode, if the time taken to complete number of bursts exceeds the internal trigger rate, an error, "Trig rate Short" will appear.

**[F3]: EXT**

Selects the external trigger signal as the trigger source. The trigger source is supplied through the TRIG IN connector.

**[F4]: NBRST**

For BURST mode only. Defines the number of burst pulses, N to be output with each trigger. N ranges from 2 to 999,999.

**[F5]: PREV**

Returns to the previous Menu selection.

**MENU Keys cont'd:**

**[SWEEP] - SWEEP Menu**

**Figure 4.9 - [SWEEP] - SWEEP Menu Tree**

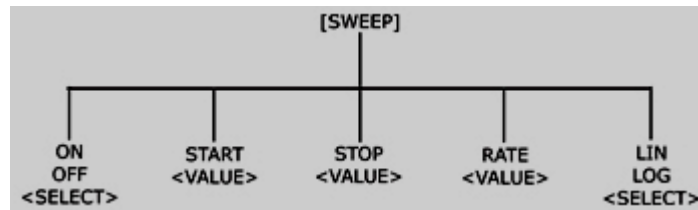

**[SWEEP] - SWEEP Menu**

The sweep function applies only to standard waveforms and is *not* used for arbitrary waveforms. Pressing the [SWEEP] key, selects the Sweep Mode and allows the sweep parameters to be entered. These are as Start, Stop, Rate and either linear or logarithmic sweep rates.

To select the sweep mode, press SWEEP, then press the function *key* that corresponds to the desired Sweep menu option, as shown:

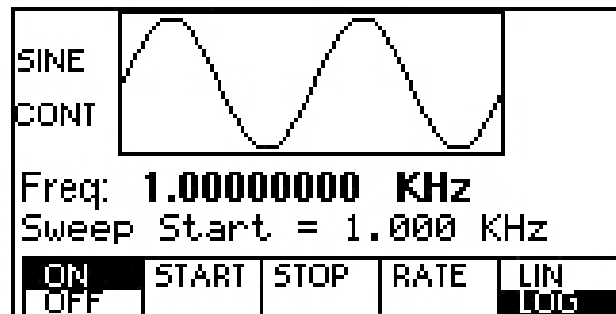

*Sweep Menu*

**MENU Keys cont'd:**

**[SWEEP] - SWEEP Menu cont'd:**

- [F1]: ON/OFF** Enables or disables the sweep function. When the sweep mode is "ON" the graphic display will show a LIN or LOG sweep type to indicate the output type.
- [F2]: START** Defines the Sweep Start frequency. The start frequency limitation is the lower frequency limit for the selected wave type. For example the lowest start frequency for a sine wave is 1  $\mu$ Hz.
- [F3]: STOP** Defines the Sweep Stop frequency. The stop frequency limitation is the highest frequency limit for the selected wave type. For example, the maximum stop frequency for a sine wave is 50 MHz.
- [F4]: RATE** Defines the Sweep Rate or time required for the sweep to occur. This interval ranges from 10 ms to 500 s.
- [F5]: LIN/LOG** Selects the Sweep Shape, LIN or LOG. The sweep shape is displayed on the LCD as shown below.

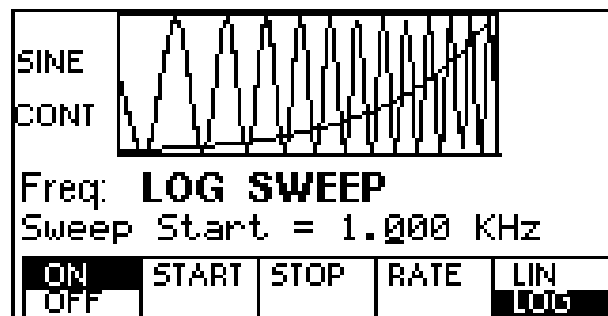

**Logarithmic Sweep Display**

Model 2732: Two Channel 50 MHz Function/Arbitrary Waveform Generator  
**Operating Instructions**

**MENU Keys cont'd:**

**[MODUL] – MODULATION Menu**

**Figure 4.10 - [MODUL] – MODULATION Menu Tree**

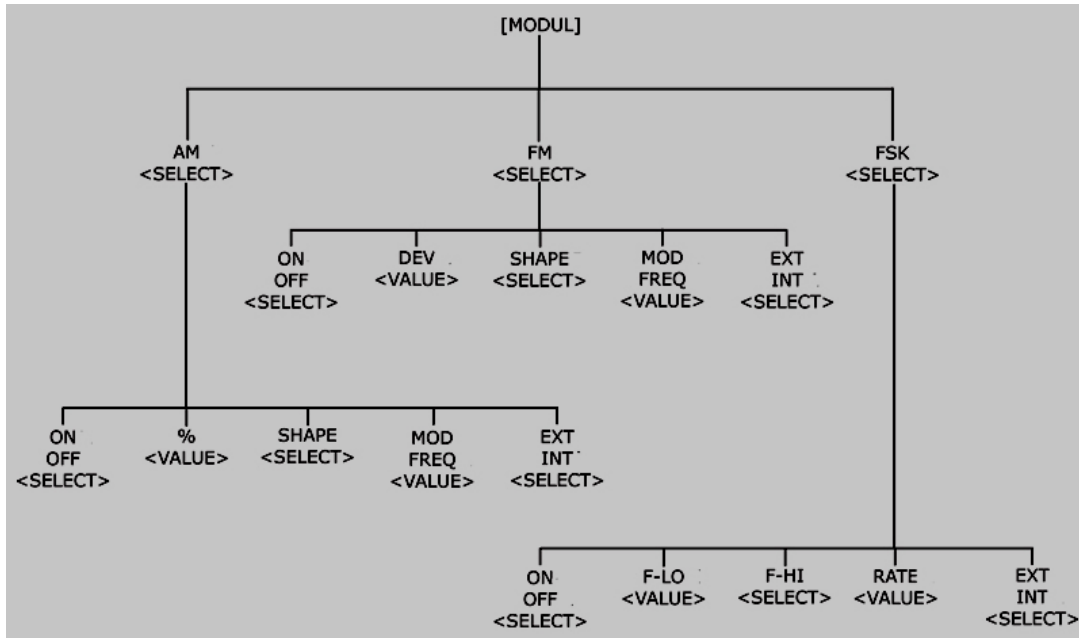

**[MODUL] – MODULATION Menu**

Selects either [F1]:AM (Amplitude Modulation), [F3]:FM (Frequency Modulation) or [F5]:FSK (Frequency Shift Key) Modes. To select the modulation type, press [MODUL], then press the function key that corresponds to the desired menu option, as shown:

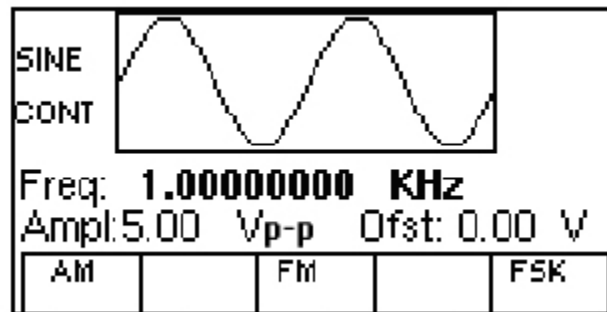

Modulation Menu

Model 2732: Two Channel 50 MHz Function/Arbitrary Waveform Generator  
**Operating Instructions**

---

**MENU Keys cont'd:**

**[MODUL]** – *MODULATION Menu cont'd:*

**[F1]: AM Menu**

If AM is selected, the following menu appears:

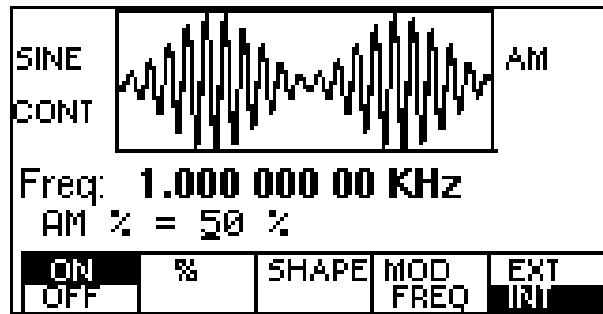

AM Menu

**[F1]: ON/OFF**

Selects the Modulation ON or OFF operating mode.

**[F2]: %**

Defines the amplitude modulation depth, from 0 to 100%.

**[F3]: SHAPE**

Selects the modulation shape between SINE, TRIANGLE or SQUARE.

**[F4]: MOD-FREQ**

Selects the modulation frequency, from 0.01 Hz to 20.00 kHz.

**[F5]: EXT/INT**

Selects and enables the external modulation by an external signal applied to the Modulation In connector.

Model 2732: Two Channel 50 MHz Function/Arbitrary Waveform Generator  
**Operating Instructions**

---

**MENU Keys cont'd:**

[MODUL] – *MODULATION Menu cont'd:*

[F3]: *FM Menu*

If FM is selected, the following menu becomes available:

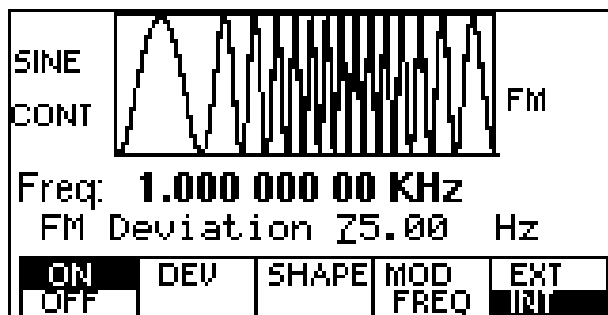

*FM Menu*

[F1]: ON/OFF  
Enables or disables the FM Modulation mode.

[F2]: DEV  
Defines the FM deviation frequency.

[F3]: SHAPE  
Selects the modulation shape between SINE, TRIANGLE or SQUARE.

[F4]: MOD/FREQ  
Selects the modulation frequency, from 0.01 Hz to 20.00 kHz.

[F5]: EXT/INT  
Selects and enables the external modulation by an external signal applied to the Modulation In connector where 5 V<sub>p-p</sub> = 100% modulation.

Model 2732: Two Channel 50 MHz Function/Arbitrary Waveform Generator  
**Operating Instructions**

---

**MENU Keys cont'd:**

[MODUL] – *MODULATION Menu cont'd:*

[F5]: *FSK Menu*

If the **FSK** is selected, the following menu is available:

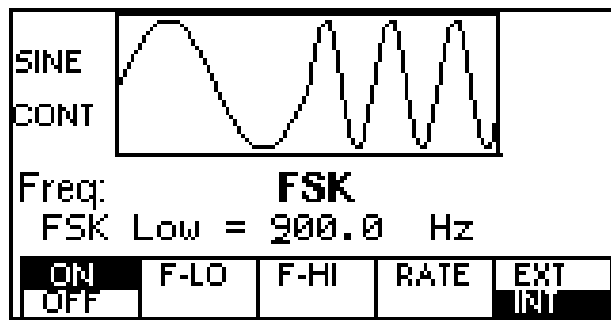

*FSK Menu*

- [F1]: **ON/OFF**      Selects the FSK ON or OFF operating mode.
- [F2]: **F-LO**        Defines the low frequency of the FSK. This is referred to as the space frequency.
- [F3]: **F-HI**        Defines the high frequency of the FSK. This is referred to as the mark frequency.
- [F4]: **RATE**        Selects the rate of the alternation between the low and high frequencies.
- [F5]: **EXT/INT**     Selects and enables the external FSK when the unit frequency is alternating between the low and high frequencies by an external signal applied to the Trig In connector. When FSK is active, the entire [MODE] menu is disabled.



**MENU Keys cont'd:**

**[SETUPS] *SETUPS Menu:***

**Figure 4.11 - [SETUPS] *SETUPS Menu Tree***

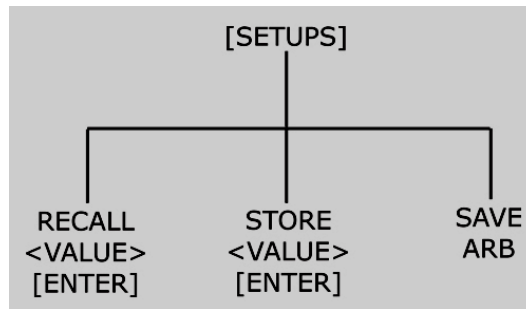

**[SETUPS] *SETUPS Menu***

The user can store the current front-panel settings, called a setup, into one of 49 (1 to 49) storage buffers. Location 0 is the reserved location for factory default settings. Both channel 1 and channel 2 settings are saved simultaneously when a setup is stored.

The 2732 automatically saves the instrument settings into memory location 50 every 10 seconds. This way the last setting before power down may be retained for later use.

When you recall a setup, the waveform generator restores the front-panel settings to those that you stored in the selected buffer. All waveform parameters & settings, except for the waveform memory data, are stored in the setup locations.

When the instrument is in arbitrary waveform mode, in addition to the [RECALL] and [STORE] keys, an additional soft key, [SAVE ARB] is available.

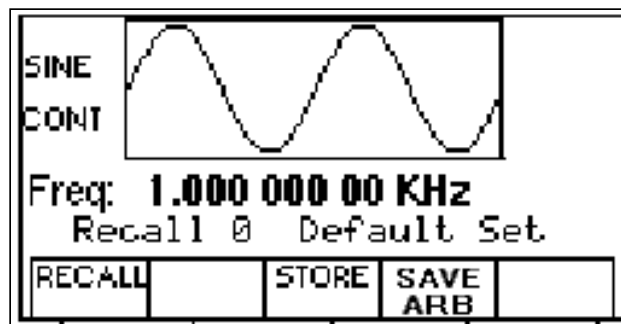

***SETUP Menu***

**MENU Keys cont'd:**

**[SETUPS] *SETUPS Menu cont'd:***

**[F1]: RECALL** Recalls a previously stored front-panel setup from the selected buffer. A recall restores settings for both channels. Change the buffer number by using the rotary input knob. Valid storage buffer numbers are from 1 to 49.

Buffer 0 is the factory default setup location. Buffer 50 will restore the last saved settings.

To recall a setting, press: [RECALL]>[MEMORY LOCATION 0-49]>[ENTER]

**[F3]: STORE** Stores the current front-panel setup to the specified storage location. Change the location number by using the data keys or the rotary input knob. Valid storage buffer numbers range from 1 to 49. Press the [ENTER] key to store the settings. A "DONE" message will appear to confirm that the current settings have been saved.

To store a setting, press: [STORE]>[MEMORY LOCATION 1-49]>[ENTER]

**[F4]: SAVE ARB** Pressing this soft key will write the arbitrary waveform memory into FLASH (non-volatile) memory. The key is visible only when the 2732 is in the ARB waveform mode.

For example, custom wave data downloaded from WaveWorks DDS to the 2732 can be written into FLASH memory by depressing the [F4]: SAVE ARB button. This way it is retained in the event that power is lost.

Model 2732: Two Channel 50 MHz Function/Arbitrary Waveform Generator  
**Operating Instructions**

---

**Front Panel Keys:**

[UTIL] - *UTILITY Menu*

Figure 4.12 - [UTIL] - *UTILITY Menu Tree*

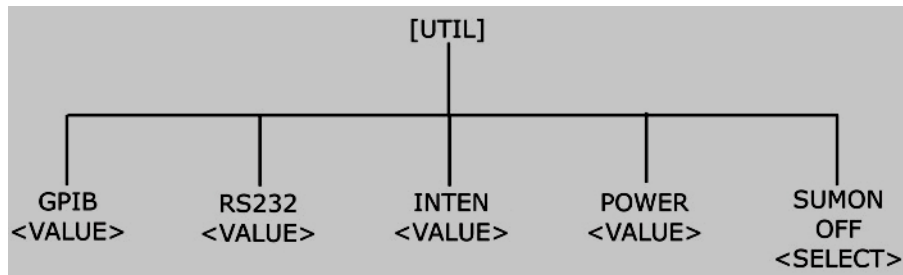

[UTIL] - *UTILITY Menu*

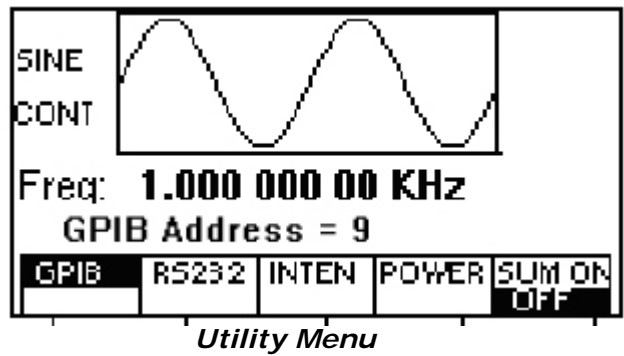

## Front Panel Keys cont'd:

### [UTIL] - *UTILITY Menu cont'd:*

- [F1]: GPIB**           Selects the GPIB mode of operation. After selection, the GPIB address can be set to any value from 1 to 31 using the rotary knob or data entry keys. Press the [ENTER] key to set the address value. The value is kept in a nonvolatile memory and is retained. The factory default address is 9. Setting the address to 31 puts the device in the off-bus state (it will not respond to messages on the GPIB bus).
- [F2]: RS232**           Selects the RS-232 remote control mode. After selection, the baud rate can be selected as 1200, 2400, 9600, 19200, 38400, 57600 or 115k. The RS-232C interface is always set to 8 data bits, 1 stop bit, and no parity.
- [F3]: INTEN**           (Intensity) Selects the intensity of the LCD display. Select a value using the numerical data keys or rotary knob. Valid numeric values are from 1 to 31. The current value is stored in nonvolatile memory, after a 20 second time-out.
- [F4]: POWER**           (Power-on default) Selects the power-on default setting. Select a value using the data keys or the rotary knob. The selection is effective after a 20 s time-out period. Select zero (0) to have the waveform generator power on with the factory default settings. Select 50 to have the waveform generator power-on with the settings it had at the last power-off. Instrument settings are automatically stored into location 50 every 10 seconds. Location 50 retains these values so that upon power up, the last instrument settings before power down are recalled. Location 50 is not user-definable.
- Select any other value in the range from 1 to 49 to have the waveform generator power-on with the settings that you have saved with SETUPS STORE in the range 1 to 49.

## Front Panel Keys cont'd:

### **[ON] - ON Key**

Use this key to control the main output signal from channel 1 or 2. When the output is active, "Ch1 On" or "Ch 2 On" is displayed depending on the output selected. This message appears in the upper right-hand side of the LCD.

### **[◀][▶] - Cursor Movement Keys**

Use these keys to move the cursor (when visible) either left or right. They are used in conjunction with the rotary input knob to set parameter values.

### **Rotary Input Knob**

Use this knob to increase and decrease numeric values or to scroll through a list. The cursor indicates the low-order position of the displayed value, which changes when you rotate the knob (for straight numeric entries only). For other types of data, the whole value changes when you rotate the knob.

### **[ENTER] – ENTER Key**

Pressing the [ENTER] key will activate a menu selection or numerical value. If the OUTPUT is enabled, then the change will take place immediately at the output. The exception is if an illegal command is received. This will produce an "Out of Range" or other error message to appear and no changes will take place at the output. If a parametric value is typed and the [ENTER] key is pressed instead of a units key, the instrument will default to the previous units of measure.

When defining arbitrary values such as marker and data locations, lengths and other soft key functions, the [ENTER] key must be pressed to activate the new value. Otherwise the data will be lost and the previous value of that parameter will be retained.

When a numerical value is being entered, the cursor will lead the position of the active digit. Pressing the [ENTER] key will return the cursor to the far left position and will add zeros to complete a numeric value. This change visually confirms new parameter activation. To enable soft key selections such as modulation or sweep ON/OFF, pressing the [ENTER] key is not required. The instrument's status is shown on the display.

### **UNITS Keys**

When defining numerical values as in frequency, time or amplitude, the units keys (located in the far right side of the keypad) serve multiple functionalities. They specify the units (frequency, time, or amplitude) for the parameter being defined. In addition, pressing a units key will automatically activate the new parametric value. If the output is enabled, the new value will be produced at the output.

The units key is an alternative to pressing the [ENTER] key when setting numeric values for wave parameters.

Model 2732: Two Channel 50 MHz Function/Arbitrary Waveform Generator  
**Operating Instructions**

---

### Power-On Settings

At power-on, the waveform generator performs a diagnostic self-test procedure to check itself for errors. If it finds an error, an error code and text appear in the display window. Other error codes appear when you enter an invalid front-panel setting. For more information on error codes, see the Error Indication section.

When the waveform generator finishes the diagnostic self-test routine, it enters the local state (LOCS) and assumes power-on default settings. Table 3-2 lists the factory default settings. You can program the waveform generator for any settings you want at power on, as described earlier in the [UTIL] section.

*Table 4.4 - Power-on Default Settings (Location 0)*

Key Function	Setting	Comments
FREQUENCY	1 kHz	Wave frequency
RATE(ARB)	1 $\mu$ s	Sample time per point
AMPLITUDE	5.00 V	Peak to peak output amplitude
FUNCTION	SINE	Output waveform
OFFSET	0.00 V	Zero offset
REPETITION	10 mS	Internal trigger rate
MODE	CONT	Waveform mode
N-BURST	2	Waves per burst
START ADRS	1	Start memory address
WAVELENGTH	1000	Number of points per waveform
TRIG SOURCE	EXT	External trigger source
OUTPUT	OFF	Output disabled
SWEEP	OFF	Sweep execution
MODULATION	OFF	Modulation execution

## Instrument Operation

### Impedance Matching

The waveform generator output circuit operates as a 50  $\Omega$  voltage source and is designed for a 50  $\Omega$  load. At higher frequencies, unterminated or improperly terminated outputs cause aberrations on the output waveform. In addition, loads less than 50  $\Omega$  reduce the waveform amplitude, while loads larger than 50  $\Omega$  increase the waveform amplitude.

Excessive distortion or aberrations caused by improper termination are less noticeable at lower frequencies, especially with sine and triangle waveforms. To ensure waveform integrity, follow these precautions:

1. Use high quality 50  $\Omega$  coaxial cables and connectors.
2. Make all connections tight and keep cable lengths as short as possible.
3. If it is necessary to reduce waveform amplitudes, use good quality attenuators.
4. Use proper termination or impedance matching devices to avoid reflections.
5. Ensure that attenuators and terminations have adequate power handling capabilities.
6. If there is a DC voltage across the output load, use a coupling capacitor in series with the load. The time constant of the coupling capacitor and load must be long enough to maintain pulse flatness.

If the waveform generator is driving a high impedance, such as a 1 M $\Omega$  input impedance (paralleled by a stated capacitance) of an oscilloscope's vertical input, connect the transmission line to a 50  $\Omega$  attenuator, a 50  $\Omega$  termination and to the oscilloscope input. The attenuator isolates the input capacitance of the device and terminates the waveform generator properly.

## Operating Instructions

---

### Instrument Operation cont'd:

#### Waveform and Execution Memory

The waveform generator uses two forms of memory:

- Dynamic RAM for generating arbitrary waveforms.
- Non-volatile FLASH for storing arbitrary waveform data and front panel settings during power off conditions.

Both dynamic RAM and non-volatile flash memories consist of 4,000,000 points at which you can specify a value from -8191 to 8191. You can scale these points through the output amplitude setting; that is, data point 8191 is equal to the positive peak of the user-defined output amplitude.

Each channel contains both types of memory for a system total of 8,000,000 points of memory in the Dynamic RAM and 8,000,000 points total in the standard FLASH.

#### *Dynamic RAM*

The DRAM is a temporary holding place for waveform data. It is used to either edit or execute wave data.

The following operations can be performed in DRAM:

- Insert and scale any of the following predefined waveforms:
  - sine
  - triangle
  - square
  - noise
- Draw a line between any two points
- Clear (set to zero) any set of points or all points
- Protect (prevent from changing) any set of points or all points
- Copy any set of points to another area
- Set individual point values

Up to 4,000,000 continuous points of waveform memory per channel can be executed by specifying a starting address in waveform memory and length.

After specifying a section of waveform memory for execution, the following parameters can be set:

- Point rate (frequency)
- Peak-to-peak amplitude (voltage)
- Offset (voltage)



Model 2732: Two Channel 50 MHz Function/Arbitrary Waveform Generator  
**Operating Instructions**

---

**Instrument Operation cont'd:**

***Nonvolatile FLASH (Arbitrary Waveform Memory)***

The FLASH retains arbitrary waveform data in the event of power loss. This memory is a matrix 16,383 x 4,000,000 that you use to plot your arbitrary waveforms. The 2732 contains two channels of identical, independent FLASH memory.

The FLASH also stores up to 49 front-panel setups. For more information see the [SETUPS] key section.

For arbitrary waveform data, the waveform generator loads the selected contents of the FLASH (arbitrary waveform memory) into the DRAM for execution.

In order to save arbitrary edited data into flash memory, the instrument needs to be in arbitrary wave mode. In this mode, when wave data is changed, the instrument displays a message "SAVE DATA" after each modification of the arbitrary waveform in the EDIT menu. Arbitrary wave data may also be saved by pressing the [SETUPS]>[SAVE ARB] keys. If the arbitrary data is not saved then it will be lost upon powering the instrument down. Because it is impossible to guarantee against loss of stored data, you should always maintain a backup of the data stored in memory so that you can manually restore such data, if necessary. This can be achieved by using WaveWorks DDS.

**Displaying Errors**

At power-on, the waveform generator performs a diagnostic routine to check itself for problems. If the diagnostic routine finds an error, an error message is displayed. The waveform generator also displays error messages when front-panel settings are either invalid or may produce unexpected results.

**Table 4.5 - Error messages for Model 2732**

Message Text	Cause
Out of range	Attempt to set variable out of instrument limits.
Setting conflict	Can't have this parameter set with some other.
Trig rate short	Internal trigger rate too short for wave/burst.
Empty location	Attempt to restore non-existent setting.
SCALE too high	Attempt to set scale too high for current dot value
Protected RAM	Attempt to write to protected RAM range.
RAM error	Error in testing RAM.
Save RAM	New firmware installed.
Must divide by 4	Predefined wavelength must be divisible by 4.
Must divide by 2	Predefined wavelength must be divisible by 2.

## Instrument Operation cont'd:

### Using The Model 2732

This section explains how to generate various waveforms and modify the output waveform including:

- Generating a standard waveform from the function generator
- Defining a Pulse Waveform
- Creating an Arbitrary Waveform: Loading Individual Data Points
- Defining a Wave segment for Execution
- Creating a Complex Arbitrary Waveform: Using Predefined Waves, Line Drawing, and the Waveform ADD Function
- Setting the Frequency
- Generating a Waveform Output
- Modifying Waveform output
- Using Voltage Offset
- Storing and Recalling a Waveform Generator Setup
- Creating and Downloading a Waveform with WaveWorks DDS software

## Instrument Operation cont'd:

### Generating a Standard Waveform

You can select several standard waveforms as: sine, triangle/ramp, square and pulse. Creating a standard waveform requires selecting the waveform type, parameters, modes, etc., and their settings that define the waveform.

Generating a standard waveform requires the following:

- Selecting the waveform
- Setting the output frequency
- Setting the output amplitude and offset
- Choosing the output trigger mode
- Enabling the output

To begin, choose a desired channel by pressing the [CHAN] key.

<b><u>Step 1 - ACTION</u></b>	<b><u>KEYSTROKES</u></b>
Select the wave type by choosing a waveform from the menu	[WAVE], then: [F1],[F2],[F3],[F4],[F5]
<b><u>Step 2 - ACTION</u></b>	<b><u>KEYSTROKES</u></b>
Set the Output Frequency using the rotary knob or data entry keys	[PARAM] <i>Set Frequency Value</i>
<b><u>Step 3 - ACTION</u></b>	<b><u>KEYSTROKES</u></b>
Set the Output Amplitude & offset by using the rotary knob or numeric keypad to set the amplitude	[PARAM] [F3]:AMPL <i>Set Amplitude Value</i> [F3]:OFST <i>Set Offset Value</i>
<b><u>Step 4 - ACTION</u></b>	<b><u>KEYSTROKES</u></b>
Set the Output Mode by choosing the desired function from the MODE menu and enabling the appropriate output	[MODE] [F1],[F2],[F3],[F4] [ON]

## Operating Instructions

---

### Instrument Operation cont'd:

#### Defining a Pulse Waveform

Before attempting to create a pulse waveform, the user should have a clear understanding of the definitions of the pulse parameters. Refer to Figures 4.5, 4.6, & 4.7 for definitions of lead time, trail time, width, and period.

In addition, the pulse parameters must meet certain constraints. These constraints are defined by the instrument's capabilities and logic. A list of these constraints is provided below:

Width < Period  
 Width  $\geq$  Period \* 1 E-6  
 Width  $\geq$  (Lead+Trail)  
 Period > Width + (Rise + Fall)  
 Lead  $\geq$  Width / 100 (or Lead = .01  $\mu$ s)  
 Trail  $\geq$  Width / 100 (or Trail = .01  $\mu$ s)  
 Rise > Period / 100,000 (or Rise = .01  $\mu$ s)  
 Fall > Period / 100,000 (or Fall = .01  $\mu$ s)

1. The first step is to sketch out a representation of the desired pulse. Determine the lead, trail, width and frequency/period in terms of the definitions used in this manual. (Figures 4.5, 4.6, & 4.7)
2. Step through each of the above inequalities to make sure that the pulse parameters meet the constraints. The above conditions must be met before you can proceed.
3. In addition, the lead, trail, and width must be set to their minimum values to allow flexibility when setting the pulse width and frequency/period.
  - a. Set lead & trail to 10 ns.
  - b. Set the width to the minimum allowable value which satisfies the condition, Width  $\geq$  P \* 1E-6.
4. Set the frequency/period to the desired value.
5. Set the width to the desired value. Make sure the width value satisfies the term, Width  $\geq$  (Lead+Trail). If it does not, then the lead and trail times may need adjusting to satisfy the inequality.
6. Set the lead and trail times to the required values. Make sure they satisfy the terms, Lead  $\geq$  Width / 100 (or Lead = .01  $\mu$ s) & Trail  $\geq$  Width / 100 (or Trail = .01  $\mu$ s).

If during parameter definition, an "Out of Range" message appears on the LCD, it is necessary to adjust the dependent parameters so that new parameters may be entered.

## Instrument Operation cont'd:

### Creating an Arbitrary Waveform

You can create an arbitrary waveform using the following methods:

- Entering individual data points
- Drawing lines between data points
- Creating a predefined waveform
- Combining any of these methods

*NOTE: You can use a software package such as **WaveWorks DDS** to create, edit and upload/download Arbitrary Waveforms. WaveWorks DDS also has the ability to import waveform data in \*.txt format. WaveWorks DDS is included at no additional charge with the purchase of any TEGAM 2720, 2725, 2730, and 2732. For more information on additional waveform software solutions, contact your local TEGAM sales office.*

There is no need to use all 4,000,000 data points /channel for one waveform. You can program any number of waveforms into waveform memory, keeping in mind the addresses where one waveform ends and the other begins.

Data to be executed may be specified by defining the starting point and data length. Data to be executed may overlap into more than one wave segment. This makes it possible to execute any predefined segment of waveform data contained within in RAM. The waveform's frequency and amplitude are influenced by the number of data points and their bit value. For further information on how the number of data points and their bit count influences the frequency and amplitude of a waveform, refer to the "Setting the Frequency" and "Setting the Amplitude" sections, respectively.

### Example Text File

Model 2732

129

257

384

509

633

etc....

## Examples:

### **Creating an Arbitrary Waveform: Loading Individual Data Points**

The most basic way to program an arbitrary waveform is to enter data points for the waveform, one data point at a time. While this can become tedious the auto-increment function helps this process.

To enter individual data points into waveform memory, follow these steps:

Specify a channel using the [CHAN] key.

1. Press [WAVE] to display the waveform selection menu.
2. Press [F5]:ARB to display the arbitrary menu.
3. Press [F4]:EDIT to display the Edit menu.
4. Press [F1]:POINT, to select the point-by-point programming mode.
5. Press [F1]:ADDRESS
6. Use the rotary knob or the numerical keys to enter the address.
7. Press [F2]:DATA.
8. Use the rotary knob or the numerical keys to enter the value for the data point. Valid entries range from -8191 to 8191.
9. Repeat steps 5 through 9 until you finish programming your arbitrary waveform.

*NOTE: Each time you press ENTER to complete a data point entry in numerical mode, the auto-increment address advances the "A= value" by one.*

**Examples cont'd:**

**Defining a Wave Segment for Execution**

To specify waveform data stored in dynamic RAM for execution, specify its starting address and length in the [F5]:ARB menu.

1. Select either channel 1 or 2 to ON using the [CHAN] key.
2. Press [WAVE] and select the [F5]:ARB function.
3. Press [F1]:START to set the address. Valid entries range from 1 to 3,999,999. Press [ENTER] to activate the start value.
4. Press [F2]:LENGTH to display the length of the waveform. Valid entries range from 2 to 4,000,000.

Use the rotary input knob or the numerical keys to enter the length of the waveform.

The example below will demonstrate how to specify the memory locations in RAM for execution.

**ACTION**

Instruct the 2732 to execute the first 1000 points of waveform data in RAM.

**KEYSTROKES**

[WAVE]  
[F5]:ARB  
[F1]:START  
[1], [ENTER]  
[F2]:LENGTH  
[1][0][0][0], [ENTER]  
[F5]:PREV  
[MODE]  
[F1]:CONT  
OUTPUT ON

## Examples cont'd:

### **Creating a Complex Arbitrary Waveform: Using Predefined Waves, Line Drawing, and the Waveform ADD Function**

To create a complex arbitrary waveform:

- Load a predefined sine waveform into arbitrary waveform memory
- Load a scaled sine wave at the positive peak of the first sine wave
- Draw a straight line between two data points in the waveform
- Add a pulse/glitch to the waveform
- Add a noise signal at the negative peak of the first sine wave

To see the waveform as you build it, connect the waveform generator to an oscilloscope and perform the following steps:

The following steps set up the waveform shown in Figure 4.2.

<b><u>Step 1 - ACTION</u></b>	<b><u>KEYSTROKES</u></b>
-------------------------------	--------------------------

*Make sure that arb memory locations, 1 to 1000 are not protected. To access the protection menu, press [WAVE]>[ARB]>[EDIT]>[MORE]>[PROT] and verify that [OFF] is selected.*

Load a 1000-point, 50% scaled, predefined sine wave into waveform memory starting at address 1

```
[WAVE]
[F5]:ARB
[START]
[1], [ENTER]
[LENGTH]
[1][0][0][0], [ENTER]
[F4]:EDIT
[F3]:PREDEF
[F1]:TYPE (rotate knob for selection)
SINE, [ENTER]
[F2]:FROM/DATA
[1], [ENTER]
[F3]:LENG
[1][0][0][0], [ENTER]
[F4]:SCALE
[5][0], [ENTER]
[F5]:EXEC
[F3]:YES
```



Model 2732: Two Channel 50 MHz Function/Arbitrary Waveform Generator  
**Operating Instructions**

---

**Examples cont'd:**

**Step 2 - ACTION**

**KEYSTROKES**

*When the [WAVE] key is pressed you will be prompted to save the data in flash memory so that the data can be retained during power down. Select [F3]: YES.*

Load a 5% scaled, 100 point predefined waveform into waveform memory starting at address 200.

[WAVE]  
[F5]:ARB  
[F4]:EDIT  
[F3]:PREDEF  
[F1]:TYPE  
SINE  
[F2]:FROM  
[2][0][0], [ENTER]  
[F3]:LENG  
[1][0][0], [ENTER]  
[F4]:SCALE  
[0][5], [ENTER]  
[F5]:EXEC  
[F3]:YES

*You should have a 2.5 Vp-p, 1 kHz sine wave on your oscilloscope. The sine wave should have a .25 Vp-p sine wave attached to it at data locations 200 to 300 (at the positive peak).*

**Step 3 - ACTION**

**KEYSTROKES**

Draw a line between address 251 (the highest point of the sine wave) and address 501 (where the sine wave crosses the origin).

[WAVE]  
[F5]:ARB  
[F4]:EDIT  
[F2]:LINE  
[F1]:FROM  
[2][5][1], [ENTER]  
[F2]:TO  
[5][0][1], [ENTER]  
[F4]:EXEC  
[F3]:YES

Model 2732: Two Channel 50 MHz Function/Arbitrary Waveform Generator  
**Operating Instructions**

---

**Examples cont'd:**

**Step 4 - ACTION**

**KEYSTROKES**

Add a negative pulse/glitch (data value -2047) at addresses 600 through 606.

[WAVE]  
[F5]:ARB  
[F4]:EDIT  
[F1]:POINT  
[F1]:ADRS  
[6][0][0], [ENTER]  
[F2]:DATA  
[-][2][0][4][7], [ENTER]  
(repeat -2047 and ENTER  
for addresses 601-606)

*Notice that every time the [ENTER] key is pressed, the address location will auto increment.*

**Step 5 - ACTION**

**KEYSTROKES**

Add a 5% noise signal to addresses 700 through 800.

[WAVE]  
[F5]:ARB  
[F4]:EDIT  
[F3]:PREDEF  
[F2]:FROM  
[7][0][0], [ENTER]  
[F3]:LENG  
[1][0][0], [ENTER]  
[F4]:SCALE  
[0][5], [ENTER]  
[F1]:TYPE  
NOISE [ENTER]  
[F5]:EXEC  
[F1]:ADD  
[F4]:EXEC  
[F3]:YES

Examples cont'd:

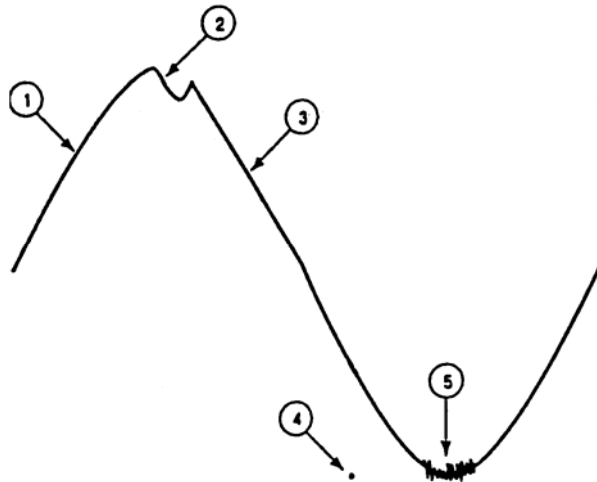

**Figure 4.13: Sine Wave with Superimposed Noise and Glitches**

**Examples cont'd:**

**Setting the Frequency**

The arbitrary waveform frequency is a function of the number of data points used to run the waveform (the length parameter in the ARBITRARY menu) and the waveform execution point rate. The waveform execution point rate is the execution time between each point in the waveform. The total time taken to run one period of the waveform is given by:

$$1 \text{ period} = \text{number of points} \times \text{execution rate}$$

Because the output frequency is a function of the rate and the number of points being executed, the output frequency of the waveform is:

$$\text{Frequency} = \frac{1}{\text{number of points} \times \text{rate}}$$

For example, to set the output frequency to 1000Hz, using 1000 data points, calculate:

$$\text{Execution Rate} = \frac{1}{1000 \text{ points} \times 1000\text{Hz}} = 1 \mu\text{s}$$

**EXAMPLE: Setting the Output Frequency**

To set the output frequency of a 1000-point waveform in execution memory to 1000Hz, set the rate to 1 $\mu$ s:

<b><u>Step 1 - ACTION</u></b>	<b><u>KEYSTROKES</u></b>
Set the output rate to 1 us (equivalent to 1000 Hz output frequency)	[PARAM] [F1]:RATE [1] [KHz/ $\mu$ s]

Once you have created the waveform, you must specify which memory segment to execute. For information about specifying a segment of memory to execute, see the section on Loading a Waveform into Execution Memory.

## Examples cont'd:

### Generating a Waveform Output

Once you load a waveform into execution memory, you can output the waveform by setting the trigger mode and output parameters (frequency, amplitude, offset).

#### Setting the Trigger Mode

To set the trigger mode:

1. Press [MODE] to display the Mode menu.
2. Press:
  - a. [F1]:CONT to select continuous mode
  - b. [F2]:TRIG to select triggered mode
  - c. [F3]:GATE to select gated mode
  - d. [F4]:BRST to select burst mode

#### Enabling the Main Output

To enable the output, choose between channel 1 and 2 then press the appropriate output key [ON].

### Modifying a Waveform's Output

You can modify the output of a waveform by:

- Using the offset
- Using modulation

### Using Voltage Offset

Through the offset parameter you can add a positive or negative DC level to the output waveform.

NOTE: For a description of the interaction between amplitude and offset settings, refer to the section on the [PARAM] menu for setting the Amplitude and Offsets of a waveform.

To set voltage offset:

1. Press [PARAM] to display the menu.
2. Press [F3]:OFST to display the offset setting.
3. Use the rotary input knob or the numerical keys to set the voltage offset. Press [ENTER] to activate the new setting.

To turn the voltage offset OFF, repeat the steps above, but set the offset voltage level to 0.

## Examples cont'd:

### **Storing and Recalling a Waveform Generator Setup (Applies to both Channels)**

You can store up to 49 front-panel setups in a part of nonvolatile RAM known as the settings storage memory. When you recall a stored setup, the front-panel settings change to match the settings in the stored setup. These stored and recalled settings include the starting address and length of the arbitrary memory that is loaded in the execution memory.

*NOTE:* Storing a waveform generator's setup values stores neither waveform nor the execution memory.

#### ***Storing Setups***

To store the front-panel setup:

1. Press SETUPS to display the menu.
2. Press [F3]:STORE to select the Store mode.
3. Use the rotary input knob to select a buffer number. Valid buffer numbers range from 1 to 49. Buffer 0 is a read-only buffer that contains the power-on settings listed in Table 4.3.

*The waveform generator does not warn you when you store a setup into a settings buffer that is already occupied.*

#### ***Recalling Setups.***

To recall stored front-panel setup:

1. Press SETUPS to display the menu.
2. Press [F1]:RECALL to select the Recall mode.
3. Use the rotary input knob to select a buffer number. Valid buffers numbers range from 0 to 50. Buffer 0 is a read-only buffer that contains the power-on settings listed in Table 4.3.
4. After selecting a setup location, press [ENTER] to activate the command.

**Examples cont'd:**

**Generating and transferring data from WaveWorks DDS to the Model 2732**

1. Install WaveWorks DDS
2. Start WaveWorks DDS,
3. Click FILE, INSTRUMENTS, select Model 2732
4. Click on INSERT
5. Click on TRIANGLE WAVE
6. Select Start Point = 1, Length = 1000, Scale = 0.50, Offset = 0.00
7. Click on COMMUNICATION, SEND WAVEFORM, RS232
8. Select Channel = 1, Start Point = 1, Length = 1000
9. Select PORT = COM1, Baud Rate = 19200
10. Apply power to 2732
11. On 2732, press UTIL, F2: RS232, set Baud = 19200 using rotary knob
12. Go to WaveWorks DDS, click SEND
13. Wave data will be transmitted to the Model 2732's channel 1. The message "Remotely Controlled – RS232" will be displayed on the Model 2732's display.

To display the data on an oscilloscope:

```
[WAVE]
[F5]: ARB
[F1]: START
[1]
[F2]: LENGTH
[1][0][0][0]
[F5]: PREV
[MODE]
[F1]: CONT
[ON]
```

Note: To save the data in flash memory, press the [SETUPS] key and then select F4:[SAVE ARB]. The instrument will prompt an "Executing" message as it stores the new waveform.

Model 2732: Two Channel 50 MHz Function/Arbitrary Waveform Generator  
**Operating Instructions**

---



INSTRUMENT DESCRIPTION  
PREPARATION FOR USE  
QUICK START INSTRUCTIONS  
OPERATING INSTRUCTIONS  
**PROGRAMMING & INTERFACING**  
SERVICE INFORMATION  
APPENDIX

Model 2732: Two Channel 50 MHz Function/Arbitrary Waveform Generator  
**Programming and Interfacing**

---

## **BNC Input and Output Connections**

### **Front Panel Output Connectors**

The function generator has two BNC connectors on the front panel, CH 1 and CH 2 OUTPUT.

#### Main Output Connectors

Use these connectors to transfer the Channel 1 and or Channel 2 output signals from the function generator to a compatible (50 $\Omega$ ) input. Use the [ON] key above Ch 1 or Ch 2 to enable or disable the output signal. An annunciator, **Out ON** appears in the upper right hand corner of the LCD when the output is enabled.

### **Rear Panel Input Connectors**

The rear panel has seven input BNC connectors. Channel 1 and channel 2 have independent SUMMING IN, MODULATION IN, and TRIG IN. The 2732 shares a common REF IN/OUT.

#### Modulation In Connectors (2)

5 Vp-p signal for 100% modulation, 10 k $\Omega$  input impedance with DC-20 kHz minimum bandwidth.

- Modulation In
- 5 Vp-p for 100% modulation.
  - 10 K $\Omega$  input impedance.
  - DC to 20 kHz minimum bandwidth.

#### Trig In Connectors (2)

Use this connector to apply a positive external TTL trigger or gate signal, depending on the waveform generator setting, to the generator.

- Trigger In
- TTL compatible.
  - Maximum rate 10 MHz.
  - Minimum width 50 ns.
  - Input impedance 1 k $\Omega$  nominal.

#### Ref In/Ref Out Connector

Use this connector to input a 10 MHz TTL signal to be used as a reference clock.

- Reference In/Out
- 10 MHz, TTL compatible

#### Summing In Connectors (2)

Use this connector to apply an external analog signal that will be added to the output waveform. A 5 Vp-p signal is required for full-scale output. The input impedance is 500  $\Omega$ .

## **BNC Input and Output Connections cont'd:**

### **Rear Panel Output Connectors**

The rear panel has five output BNC connectors, (1) REF In/Out, (2) Marker Outputs, (2) Sync outputs.

#### Ref In/Out Connector

A 10 MHz TTL output signal is available for synchronization of external units, when the 2732 is not in External Reference mode.

Reference IN/OUT - 10 MHz, TTL compatible

#### Marker Out Connectors (2)

The marker output connector provides a positive, TTL-level pulse at its output when either channel of the 2732 is in the arbitrary waveform mode. The beginning address location and the length of the marker pulse is defined by the user. The output of this connector may be enabled or disabled by the user.

The marker output signal is disabled when the 2732 is in standard waveform mode (operating as a function generator) or when the marker is assigned an inactive address.

#### Sync Out Connectors (2)

In standard or arbitrary waveform mode, these outputs provide positive TTL sync pulses generated at the beginning of each waveform cycle. The frequency of the pulse follows the output frequency of the standard wave at a 50% duty cycle.

Sync Out - TTL pulse at programmed frequency, 50  $\Omega$  source impedance.

## RS-232C Programming

### General

For RS-232C interface to a PC, use a 9-pin female to 9-pin female cable. The cable should be of a null modem type and should be wired as follows:

*Figure 5.1 - Cable End View*

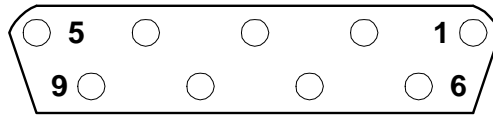

**Table 5.1: Pin Designations for RS-232C Cable**

9 PIN	9 PIN
	No Connection
TXD (3)	RXD (2)
RXD (2)	TXD (3)
DTR (4)	DSR (6)
Signal Ground (5)	Signal Ground (5)
DSR (6)	DTR (4)
RTS (7)	CTS (8)
CTS (8)	RTS (7)
RI (9)	No Connection

RS-232C specifies the electrical characteristics and pin configurations used for connecting "data terminal equipment" (DTE) to "data communication equipment" (DCE). Data terminal equipment includes devices such as terminals, computers, or printers that are the final destination for data. Data communication equipment is usually a modem or other device that converts the data to another form and passes it through. The instrument can be configured only as a DCE, so in most cases it can be connected with a null-modem to a computer, but would require special cabling to connect to another DCE device.

Be sure that you have the Remote Mode of 2732 set to RS-232C and the baud rate configured correctly. The baud rate is the bit rate during the transmission of a word in bits per second. The baud rates of two interfaced devices must be the same. The instrument can be set to different baud rates from 1200 to 115k (1200, 2400, 4800, 9600, 19,200, 38,400, 57,600 and 115,000). Make sure the baud rate of the 2732 matches that of the PC. The baud rate of the 2732 can be accessed by pressing [UTIL]>[RS232] and then adjusting the dial until the required baud is displayed. Hit [ENTER] to activate the new baud setting. The instrument uses 8 data bits, 1 stop bit, and no parity.

## **RS-232C Programming**

Data signals over the RS-232C use a voltage of +3 V to +25 V to represent a zero (called a space) and a voltage of -3V to -25V to represent a one (called a mark). Handshake and control lines use +3 V to +25 V to indicate a true condition and -3 V to -25 V to indicate a false condition.

When no data is being transmitted, the idle state of the data lines will be the mark state. To transmit a byte, the transmitting device first sends a start bit to synchronize the receiver.

### *RS-232C Operation*

The RS-232C standard is not very specific about many of the handshaking signals and it is therefore usually necessary to refer to the manuals for both of the devices being connected to determine the exact pin out, signal definition, and signal direction for the devices.

The serial interface implements the same SCPI command set as the GPIB interface. The instrument is programmed by sending ASCII coded characters to the instrument. When the instrument is in the remote mode, remote command input has priority over any front panel control. Therefore, as long as the serial interface is continuously supplied with data, the front panel keys will appear to be inoperative to the user.

The instrument accepts a carriage return (CR) as an end of string (EOS) terminator and sends both a CR and line feed (LF) as the EOS terminator.

## GPIB Interface

### Overview

This section provides detailed information on programming the Model 2732 via the IEEE-488 bus (GPIB - General Purpose Interface Bus). The Model 2732 is programmable over the GPIB bus, and its message protocol is compatible with IEEE 488.2. The device command set is compatible with the SCPI 1992.0 standard.

**Figure 5.2 - GPIB Connector Pin Assignments**

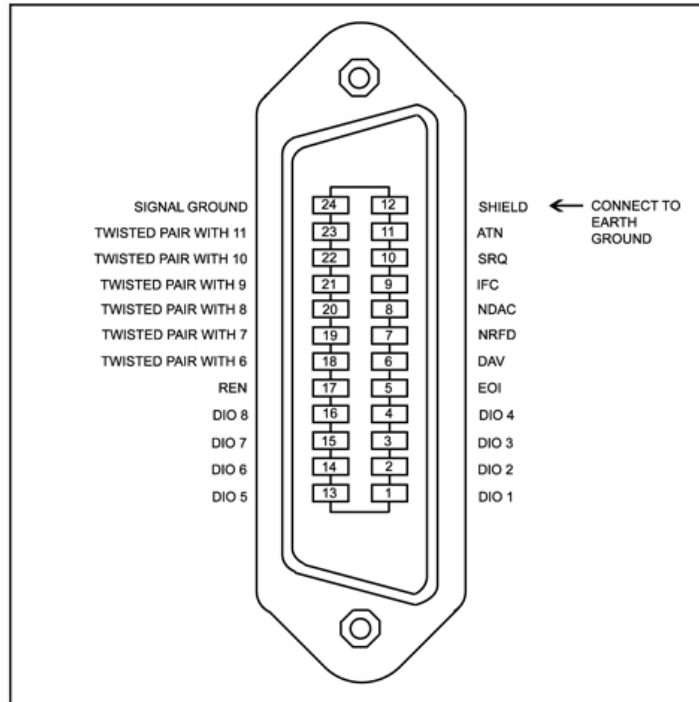

The command syntax as defined by the IEEE 488.2 and SCPI standards is briefly explained in the following sections. Users who have experience programming GPIB instruments may skip these sections, and go directly to where the individual command syntax is given. Considering the relative newness of these standards, it is recommended to all users to read the explanations given here. Users wishing to gain further insight should consult the standards.



## **Device State**

The 2732 may be in one of four possible states described below. The transition between states is defined by IEEE 488.1.

### *Local State (LOCS)*

In the LOCS the device may be operated from the front panel only. Its settings may be queried over the GPIB, but not changed. Commands that do not affect the signal being output by the instrument are accepted.

### *Local With Lockout State (LWLS)*

In the LWLS the device may be operated from the front panel only. Its settings may be queried over the GPIB, but not changed. Commands that do not affect the signal being output by the instrument are accepted. The difference between the LOCS and the LWLS is that the LWLS device may enter the Remote With Lockout State.

### *Remote State (REMS)*

In the REMS the device may be operated from the GPIB. Actuating any front panel key will cause the device state to revert to the LOCS.

### *Remote With Lockout State (RWLS)*

In the RWLS the device is operable only from the GPIB. Front panel operation may be returned by either sending an appropriate IEEE 488.2 command, or by cycling the device power.

## Interface Function Subsets

The following interface function subsets are implemented in the Model 2732:

SH1, AH1, T6, L4, SR1, RL1, PP0, DC1, DT1, E2, C0

## Device Address

The GPIB address of the 2732 may be set to any value from 0 to 31. The address may be changed from the front panel, using the numeric keypad or the rotary encoder, or via the GPIB itself using the command:

:SYSTem:COMMunicate:GPIB:ADDRess

Setting the device to address 31 puts it in the 'off-bus' state. In this state it will not respond to messages on the GPIB. If the device is in the REMS when set to address 31, an internal 'return-to-local' command will be given, setting the device to the LOCS. If the device is in the RWLS, the 'return-to-local' command is ignored, and the device remains in the RWLS. The only way to then re-establish communication with the device over the GPIB is to cycle the power, and to then change the address to that required from the front panel.

## Message Exchange Protocol (MEP)

The 2732 decodes messages using the Message Exchange Protocol defined in IEEE 488.2. The following functions implemented in the MEP must be considered:

### *The Input Buffer*

The device has a 256-byte long cyclic input buffer. Decoding of remote messages is begun as soon as the input buffer is not empty, that is, as soon as the controller has sent at least one byte to the device. Should the input buffer be filled up by the controller faster than the device can remove the bytes and decode them, the bus handshake is not completed until room has been made for more bytes in the buffer. This prevents a fast controller from overrunning the device with data.

If the user has sent part of a Program Message, but not the Program Message Terminator, and he wishes to abort the message decoding and execution, the Device Clear command may be sent, or front panel operation resumed (in REMS only).

### *The Output Queue*

The device has a 100-byte long output queue in which it stores response messages for the controller to read. If at the time a response message is formatted the queue contains previously formatted response messages, such that there is not enough place in the queue for the new message, the device will put off putting the message in the queue until there is room for it.

When the Status Byte MAV bit is set, it indicates that all or part of a response message is ready to be read.

### *Response Messages*

The device sends a Response Message in response to a valid query. All queries return a single Response Message Unit. In only one case is the Response Message generated when the response is read (as opposed to when the response is parsed), and this is when querying Arbitrary Waveform data. All other queries generate the Response Message when they are parsed.

### *Coupled Commands*

Coupled Commands are either commands whose execution validity depends on the value of other parameters, or commands whose execution changes the value of another parameter. The execution of commands designated as being coupled is deferred until all other commands in the same Program Message have been executed. The coupled commands are then grouped together according to their functionality, and executed as a group.

These groups of coupled commands are defined in the Model 2732:

- a) Commands to set the amplitude, the offset, and to switch the output on. The output being switched on is included here in order to prevent possible damage to the equipment being driven as a result of the amplitude and offset not being executed as intended by the user, due to an execution error.
- b) Commands to set the function, frequency, the point rate, the wavelength, and the waveform start address. In ARB mode, the frequency and the point execution rate are dependent upon each other keeping the wavelength constant (unless it is specified in the same program message). If the wavelength is specified as well, the frequency or point rate must change in accordance with the new value. The validity of the start address is a function of the wavelength. Please refer to the individual commands for more detail.  
The maximum frequency is also dependant upon the waveform, so that changing the waveform may render the current frequency out of range.
- c) Commands to set modulation, modulation source and the function are inter-related. FM and FSK are not available for ARB function. External source of modulation can be active for either FM or AM but not both. FSK and FM cannot be active at the same time.
- d) Sweep start and sweep stop frequencies must be distanced more than the minimum allowed for sweep to function correctly.

## **Block Data**

Arbitrary waveform values may be sent to the device in one of three formats:

- a) ASCII values,
- b) Definite form arbitrary data, and
- c) Indefinite form arbitrary data.

Essentially we would like to check the execution validity of all the data of a command before execution. When downloading a long arbitrary waveform, however, it is not possible to check all the data sent before execution, since this would require excessive amounts of memory. The following compromise has therefore been reached:

An arbitrary waveform is limited in length only by the amount of waveform memory. Each point is checked and then written to memory. If an invalid value is detected all subsequent values are discarded, and an execution error is flagged.

Querying arbitrary waveform data will result in a Response Message containing only as many points as the user requested.

## **Instrument Identification**

The \*IDN? common query is used to read the instrument's identification string. As of September 2006, the string returned is as follows:

**Tegam, 2732,0,V1.XX**

## **Instrument Reset**

The \*RST common command restores an instrument to its factory default settings.

## **Self Test**

The \*TST common query causes the device to perform a self-test. This self-test consists of checking the functionality of the arbitrary waveform memory.

## Command Syntax

### *General Command Structure*

The device commands are generally defined by the SCPI standard, with the exception of those instrument functions for which SCPI commands do not as yet exist. The Common Commands and Queries are defined by IEEE 488.2. The command syntax, i.e., how a command is structured, is defined by IEEE 488.2.

A Program Message is defined as a string containing one or more Program Message Units, each of which is an instrument command or query. Program Message Units are separated from each other by the Program Message Unit Separator. The Program Message is terminated by the Program Message Terminator.

The Program Message Unit Separator consists of a semicolon (';'), optionally preceded and/or followed by white space characters. A white space character is defined as the ASCII characters in the ranges 00H-09H, and 0BH-20H. This range includes the ASCII control characters and the space, but excludes the Linefeed character.

The Program Message Terminator consists of optional white space characters, followed by one of three options:

- a) The Linefeed (LF) character (ASCII 0A);
- b) The GPIB EOI bus line being set true on the last byte of the message;
- c) LF being sent with EOI true.

The Program Message Unit can be divided into three sections as follows:

#### a) Program Header

The Program Header represents the operation to be performed, and consists of ASCII character mnemonics. Two types of Program Headers are used in the 2732: Instrument-control headers and Common Command and Query headers.

A Program Header may consist of more than one mnemonic, in which case the mnemonics are separated from each other by the colon (':').

For instrument control commands, the mnemonics are specified by the SCPI standard, and indicate the tree structure of the command set. The first mnemonic indicates the subsystem being controlled. Common Command and Query Program Headers consist of a single mnemonic prefixed by an asterisk ('\*').

The mnemonics consist of upper - or lower-case alpha characters. Mnemonics may be written in either the long form, in which the entire mnemonic is written out, or the short form, in which only a specified portion of the mnemonic is written out. Some mnemonics have only one form due to their short length. Where a command is described, the portion appearing in upper case is the short form. Only the short form or the long form may be used.

Example: The command to set the frequency to 1KHZ may be written in the following ways:

```
SOURCE:FREQUENCY 1KHZ
SOUR:FREQ 1KHZ
SOURCE:FREQ 1KHZ
```

\*Note: To use channel 2, replace "SOURCE" with "SOURCE2" or "SOUR" with, "SOUR2".

Some mnemonics in a specified Program Header may be optional. This is indicated in the command description by the mnemonic being enclosed in square brackets ([...]). This means it is not necessary to write the mnemonic when addressing Channel 1: it is a default condition. The 'SOURCE' mnemonic, for example, is optional. Not specifying it will cause the device to search for the mnemonics in the Program Header under the Source Subsystem. For example, the frequency may be set by the commands since the 'CW' mnemonic is also optional.

```
FREQ:CW 1KHz
FREQ 1KHz
```

\*Note: To access Channel 2, you must specify the second channel subset of commands. In the example above you would still need to include SOURCE2: "SOUR2:FREQ 1KHz"

#### b) Program Header Separator

The Program Header Separator is used to separate the program header from the program data. It consists of one or more white space characters, denoted as <ws>. Typically, it is a space.

#### c) Program Data

The Program Data represent the values of the parameters being set, for example, the '1KHZ' in the above examples. Different forms of program data are accepted, depending on the command. The Program Data types used in the instrument are:

##### i) *Character Program Data*

This form of data is comprised of a mnemonic made up of lower - or upper-case alpha characters. As with Program Header mnemonics, some Character Data mnemonics have short and long forms. Only the short or the long form may be used.

ii) *Boolean data*

Boolean data indicate that the parameter can take one of two states, ON or OFF.

The parameter may be character type or numeric.

ON or OFF

A numeric value is rounded to an integer. A non-zero result is interpreted as 1 (ON), and a zero result as 0 (OFF).

Queries return the values 0 or 1.

iii) *NR<sup>f</sup>*

This is a decimal numeric data type, where (f=1, 2, or 3)

NR1 indicates an integer number,

NR2 indicates a fixed point real number, and

NR3 indicates a floating-point real number.

iv) *Expression Data*

An expression is contained in parentheses (...). This data type is used only with the STATus:QUEue:ENABLE command.

v) *Numeric Value Program Data*

This data type defines numeric values, as well as special cases of Character Data.

Numeric values may be specified in any of Integer, Fixed Point or Floating Point format. All parameters, which have associated units accept a suffix, which may be specified using upper or lower-case characters. When the suffix is not specified, the numeric value is accepted in the default units, which are Hertz for frequency, Seconds for time, and Volts for voltage. To set the frequency on Channel 1 to 1KHz we can send one of the following commands:

```
FREQ 1000  
FREQ 1E3
```

The special forms of character data accepted as numbers are

MAXimum: sets the parameter to its maximum value.

MINimum: sets the parameter to its minimum value.

For example, to set the frequency to it's maximum value we can send the command

```
FREQ MAX
```

To set the maximum frequency on Channel 2 we can send the command

```
SOURCE2:FREQ MAX
```

vi) Arbitrary Block Data

The Arbitrary block data type is used to send arbitrary waveform data to the instrument. In this data type, the waveform points are specified in binary format, and each point consists of two bytes. Two types of arbitrary block data are defined (by IEEE 488.2):

Definite Form:

The Definite Form has the structure

-#-Byte Count Length - Byte Count - 8-bit byte

The Byte Count Length consists of a single ASCII digit from 1 to 9. It tells the parser how many digits are in the Byte Count.

The Byte Count is a decimal integer made up of the number of digits specified in the Byte Count Length. It tells the parser how many 8-bit bytes are being sent.

Indefinite Form:

The Indefinite Form has the structure

- # - 0 - 8-bit byte - LF^EOI

Some Program Message Units either require, or can accept, more than one data element. Program data elements are separated from each other by the Program Data Separator. It is defined as optional white space characters followed by a comma (','), which in turn is followed by optional white space characters.

There are two types of Program Message Units: Command Message Units and Query Message Units. A Query differs from a Command in that the Program Header is terminated with a question mark ('?'). For example, the frequency might be queried with the following query:

FREQ?

Some Query Message Units accept data, giving the device more specific information about what is being queried. In many cases the Query Message Unit may optionally be supplied with the MIN or MAX mnemonics as data. This tells the device to return the minimum or maximum value to which the parameter may currently be set. For example,

FREQ? MAX

will return the maximum value to which the frequency may currently be set.



Not all Program Message units have query forms (for example, STATUS: PRESET), and some Program Message Units might have only the query form (for example SYSTEM: VERSION?).

The instrument puts the response to the query into the output queue, from where it may be read by the controller. The Status Byte MAV bit is set to indicate to the controller that a response is ready to be read.

### *SCPI Command Structure*

SCPI commands are based on a hierarchical structure. This allows the same instrument-control header to be used several times for different purposes, providing that the mnemonic occurs in a unique position in the hierarchy. Each level in the hierarchy is defined as a node.

Mnemonics in the different levels are separated from each other by a colon (':'). The first Program Message Unit, or command, in a Program Message is always referenced to the root node. Subsequent commands are referenced to the same level as the previous command. A Program Message Unit having a colon as its first character causes the reference to return to the root. This process is defined by IEEE 488.2, section A.1.1. Consider the following examples:

- a) The following command may be used to set the amplitude and the offset of the signal.

```
SOURCE:VOLTAGE:AMPLITUDE 5V;OFFSET 2V
```

Note that the offset command is referenced to the command preceding it: the OFFSET mnemonic resides at the same node as the AMPLITUDE command.

- b) This command set the frequency and the amplitude for Channel 2.

```
SOURCE2:FREQUENCY 2KHZ;VOLTAGE:AMPLITUDE 4V
```

The FREQUENCY and VOLTAGE mnemonics are at the same level.

- c) When Program Message Units describe different subsystems, a colon prefix must be used to reset the command reference to the root. Here the frequency and the output state are set.

```
SOURCE:FREQUENCY 3KHZ;;OUTPUT:STATE ON
```

Common Commands may be inserted in the Program Message without affecting the instrument-control command reference. For example,

```
SOURCE:VOLTAGE:AMPLITUDE 4V;*ESE 255;OFFSET 2V
```

## Status Reporting

The instrument is capable of reporting status events and errors to the controller, using the IEEE 488.2 Service Request function and the IEEE 488.2 Status Reporting structure.

### *The Status Byte*

Status summary information is communicated from the device to the controller using the Status Byte (STB). The STB is composed of single-bit summary-messages, each summary message summarizing an overlying Status Data Structure. By examining the content of the STB, the controller gains some information concerning the instrument's status.

The STB bits are defined as follows:

- Bit 0: Unused
- Bit 1: Unused
- Bit 2: Error/event queue summary message (EVQ). This bit is set if the queue is not empty.
- Bit 3: Questionable Status summary message.
- Bit 4: Message Available (MAV) summary message. This bit is set whenever all or part of a message is available for the controller to read. The controller may be ready to read the response message before it is available, in which case it can either wait until this bit is set, or it can start to read. In the second case, the controller timeout must be set so that the read action will not be aborted before the message has been read.
- Bit 5: Event Status Bit (ESB) summary message. This bit is set to indicate that one or more of the enabled standard events have occurred.
- Bit 6: Request Service (RQS). This bit is set when the device is actively requesting service.
- Bit 7: Operation Status summary message. No Operation Status events are defined in the instrument, and so this bit is never set.

The STB is read by the controller during a serial poll. If the RQS bit was set, it is then cleared. The STB may also be read by the \*STB? common query.

### *Service Request Enabling*

Service request enabling allows the user to select which Status Byte summary messages may cause the device to actively request service. This is achieved using the Service Request Enable Register, which is an 8-bit register whose bits correspond to those of the STB. The RQS bit in the STB is set when a bit in the STB is set, and its corresponding bit in the service request enable register is set.

The service request enable register is set using the \*SRE common command, and read using the \*SRE? common query.

### *Standard Event Status Register*

The Standard Event Status Register (SESR) is defined by IEEE 488.2. It is implemented in the instrument as a byte, whose bits have the following definitions:

- Bit 0: Operation Complete (OPC). This bit is set in response to the \*OPC common command being executed.
- Bit 1: Request Control (RQC). Not implemented.
- Bit 2: Query Error (QYE). This bit is set when either the controller is attempting to read data from the device when none is available, or when data prepared for the controller to read has been lost.
- Bit 3: Device-Specific Error (DDE). This bit is set to indicate that a device operation did not execute due to some device condition. For example, trying to recall an uninitialized device stored setting.
- Bit 4: Execution Error (EXE). This bit is set when the device could not execute a command, due to the command being outside of its capabilities. For example, an out of range parameter.
- Bit 5: Command Error (CME). This bit is set to indicate an error in the command syntax.
- Bit 6: User Request (URQ). This bit is not used.
- Bit 7: Power On (PON). This bit is set when the device is powered on.

The SESR is queried using the \*ESR? common query.

The SESR is paired with an enable register, the Standard Event Status Enable Register (SESER). This register enables one or more events in the SESR to be reflected in the Status Byte ESB summary message bit. The bits of the SESER correspond to those of the SESR. Setting a bit in the SESER enables the corresponding event to set the ESB bit when it occurs. The SESER is set with the \*ESE common command and queried with the \*ESE? command query.

### *The Error Queue*

The error queue is used to store codes of errors detected in the device. It is implemented as a cyclic buffer of length 10. When the error queue is not empty, bit EVQ in the Status Byte is set. The error queue is read with either one of the following two queries:

```
:SYSTEM:ERROR?  
:STATUS:QUEUE:NEXT?
```

The first error in the queue is returned, and the queue is advanced.

## Error Codes

The negative error codes are defined by SCPI. Positive codes are specific to the instrument.

The error message is returned in the form

<error number>,"<error description>"

A table of error numbers and their descriptions is presented here.

No error reported

0                      No error

### Command Errors

A command error is in the range -199 to -100, and indicates that a syntax error was detected. This includes the case of an unrecognized header. The occurrence of a command error causes the CME bit (bit 5) of the Standard Event Status Register to be set.

**Table 5.2: Summary of Command Errors**

ERROR CODE	DESCRIPTION	ERROR CODE	DESCRIPTION
100	Command Error	124	Too many digits. Maximum of 255 digits in mantissa.
101	Invalid character	128	Numeric data not allowed. A different data type was expected
102	Syntax error	131	Invalid suffix
103	Invalid separator	134	Suffix too long. A maximum of 12 characters are allowed.
104	Data type error	138	Suffix not allowed
105	GET not allowed	140	Character data error.
108	Parameter not allowed. More parameters than allowed were received.	141	Invalid character data. Incorrect character data was received.
109	Missing parameter. Fewer parameters than necessary were received	144	Character data too long. Character data may contain no more than 12 characters.
110	Command header error	148	Character data not allowed
111	Header separator error	158	String data not allowed
112	Program mnemonic too long. No more than 12 characters allowed.	161	Invalid block data. An error was found in the block data
113	Undefined header	168	Block data not allowed
120	Numeric data error	170	Expression error. Only 6 error ranges may be specified.
121	Invalid character in number	171	Invalid expression. An error was found in the expression.
123	Exponent too large. IEEE 488.2 specifies maximum of 32000	178	Expression data not allowed

Model 2732: Two Channel 50 MHz Function/Arbitrary Waveform Generator  
**Programming and Interfacing**

---

*Execution Errors*

An execution error indicates that the device could not execute a syntactically correct command, either since the data were out of the instrument's range, or due to a device condition. The EXE bit (bit 4) of the Standard Event Status Register is set on occurrence of an execution error.

**Table 5.3: Summary of Execution Errors**

ERROR CODE	DESCRIPTION	ERROR CODE	DESCRIPTION
200	Execution error. An attempt was made to RECALL the contents of an uninitialized stored setting buffer.	222	Data out of range.
201	Invalid while in local.	223	Too much data. The arbitrary waveform memory limit has been exceeded.
211	Trigger ignored. The GET or *TRG common command was ignored due to the device not being in the correct state to execute the trigger.	224	Illegal parameter value. The parameter value must be selected from a finite list of possibilities.
220	Parameter error. A parameter is in the correct range, but conflicts with other parameters.	258	Media protected. An attempt was made to write to protected arbitrary waveform memory.
221	Settings conflict. The parameter is out of range due to the current instrument state.		

*Device-Specific Errors*

An error specific to the device occurred. The DDE bit (bit 3) of the Standard Event Status Register is set.

**Table 5.4: Summary of Device Specific Errors**

ERROR CODE	DESCRIPTION	ERROR CODE	DESCRIPTION
315	Configuration memory lost. Device memory has been lost.	350	Queue overflow. Error codes have been lost due to more than 10 errors being reported without being read.
330	Self-test failed.		

### Query Errors

A query error indicates that the output queue control has detected a problem. This could occur if either an attempt was made to read data from the instrument if none was available, or when data were lost. Data could be lost when a query causes data to be formatted for the controller to be read, and the controller sends more commands without reading the data.

**Table 5.5: Summary of Query Errors**

ERROR CODE	DESCRIPTION	ERROR CODE	DESCRIPTION
410	Query INTERRUPTED. Data were sent before the entire response of a previous query was read.	430	Query DEADLOCKED. The input buffer and output queue are full, and the controller is attempting to send more data. In this case the output queue and input buffers will be cleared. Parsing will resume after the END message is detected.
420	Query UNTERMINATED. An attempt was made to read a response before the complete program message meant to generate that response was sent.	440	Query UNTERMINATED after indefinite response. A query was received in the same program message after a query requiring an indefinite response was formatted. Essentially this means that the *IDN? common query and the :ARB:DATA? query should not be followed by more query messages in the same program message.

### System Events

System events have positive valued codes. They are not defined by SCPI, but are specific to the instrument. Sending the :STATus:PRESet command will disable these events from being reported.

**Table 5.6: Summary of System Events**

EVENT CODE	DESCRIPTION	EVENT CODE	DESCRIPTION
401	Power on	402	Operation complete The *OPC command has been executed.

*Warnings*

The execution of some commands might cause an undesirable instrument state. The commands are executed, but a warning is issued. Sending the :STATus:PRESet command disables reporting of warnings. The existence of these conditions causes a bit in the Status Questionable Condition register to be set (refer to section 13.5.4).

**Table 5.7: Summary of Warnings**

<b>EVENT CODE</b>	<b>DESCRIPTION</b>	<b>EVENT CODE</b>	<b>DESCRIPTION</b>
500	Trigger rate short	510	Output overload

"Trigger rate short" means that the period of the waveform is larger than the value of the internal trigger rate. Thus, not every trigger will generate a cycle (or burst) of the waveform.

## IEEE 488.2 Common Commands

### *System Data Commands*

a) **\*IDN?** - Identification query

The identification query enables unique identification of the device over the GPIB. This query should always be the last in a program message. It returns a string with four fields:

Manufacturer name  
Model name  
Serial number (0 if not relevant)  
Version number

Command  
Type: Common Query  
Syntax: \*IDN?  
Response: TEGAM, 2732,0,V1.XX

b) **\*OPT?** - Option identification query

The Option Identification Query is used to identify device options over the system interface. This query should always be the last in a program message.

Command  
Type: Common Query  
Syntax: \*OPT?  
Response: No option available.

### *Internal Operation Commands*

a) **\*RST** - Reset command

The Reset command performs a device reset. It causes the device to return to the factory default power up state.

Type: Common Command  
Syntax: \*RST

b) **\*TST?** - Self-test query

The self-test query causes an internal self-test to be performed. This test consists of checking the integrity of the arbitrary waveform memory.

Type: Common Query  
Syntax: \*TST?  
Response: ASCII 0 if test passes  
ASCII 1 if test fails



*Synchronization Commands*

a) **\*OPC** - Operation complete command

The operation complete command causes the device to generate the operation complete message in the Standard Event Status Register, on completion of the selected device operation.

Type: Common Command  
Syntax: \*OPC

Examples: `FREQ 5KHZ;*OPC`

The \*OPC command (and the \*OPC? query described below) find use mainly when commands having relatively long execution times are executed, for example the programming of long predefined waveforms.

b) **\*OPC?** - Operation complete query

The operation complete query places an ASCII character 1 in the output queue on completion of the selected device operation.

Type: Common Query  
Syntax: \*OPC?  
Response: ASCII character 1  
Example `FREQ 1KHz;*OPC?`

c) **\*WAI** - Wait-to-continue command

This command is intended for use with overlapped commands. No commands in the instrument are overlapped, and so this command has no effect.

Type: Common Command  
Syntax: \*WAI

*Status and Event Commands*

a) **\*CLS** - Clear status

The clear status command clears the SESR and Error Queue status data structures.

Type: Common Command  
Syntax: \*CLS

b) **\*ESE** - Standard event status enable

This command is used to set the value of the Standard Event Status Enable Register.

Arguments

Type: NRf  
Range: 0 to 255. Non-integer arguments are rounded before execution.  
Type: Common Command or Query  
Syntax: \*ESE<ws><NRf>  
Examples: \*ESE 48 (Enables the CME and EXE bits)  
\*ESE 255 (Enables all standard events)

Query

Syntax: \*ESE?  
Response: <NR1>

c) **\*ESR?** - Standard event status register query

This query is used to read the value of the Standard Event Status Register. Reading the register clears it.

Type: Common Query  
Syntax: \*ESR?  
Response: <NR1>

d) **\*PSC** - Power on status clear command

This command is used to control the automatic power-on clearing of certain status functions.

Arguments

Type: Boolean  
Type: Common Command or Query

Command

Syntax: \*PSC<ws><Boolean>  
Examples: \*PSC ON or \*PSC 1  
\*PSC OFF or \*PSC 0

Query

Syntax: \*PSC?  
Response: ASCII 0 for OFF  
ASCII 1 for ON

When set to ON (1), the Service Request Enable Register and the Standard Event Status Enable Register are cleared on power-on.

e) **\*SRE** - Service request enable command

This command sets the Service Request Enable Register bits.

Arguments

Type: NRf  
Range: 0 to 255. Non integer arguments are rounded before execution.  
The value of bit 6 is ignored, and is set always to zero.  
Type: Common Command or Query

Command

Syntax: \*SRE<ws><NRf>  
Examples: \*SRE 48 (Enables reporting of ESB and MAV events)

Query

Syntax: \*SRE?  
Response: <NR1>

f) **\*STB?** - Status byte query

This query is used to read the value of the Status Byte.

Type: Common Query  
Syntax: \*STB?  
Response: <NR1>

The value of the Status Byte read with the \*STB? query may differ from that read with the Serial Poll. Bit 6 of the STB will be set as long as a reason for requesting service exists, while bit 6 of the STB as read by the Serial Poll is cleared by the Serial Poll.

*Device Trigger Commands*

a) **\*TRG** - Trigger command

This command is analogous to the IEEE 488.1 Group Execute Trigger interface message, and has the same effect. It is used to trigger the device to output a wave, and is accepted only when the trigger mode is set to Trigger, Gate or Burst, and the trigger source is set to BUS.

Type: Common Command  
Syntax: \*TRG

*Stored Settings Commands*

a) **\*RCL** - Recall instrument state

This command is used to restore the state of the device to that stored in the specified memory location.

Arguments

Type <NRf>  
Range 0 to 49. Non integer values are rounded before execution

Type: Common Command  
Syntax: \*RCL<ws><NRf>  
Example: \*RCL 0 (Recall default state)  
\*RCL 49

Stored setting location 49 stores the last instrument setting before power down.

b) **\*SAV** - Save instrument state

This command is used to store the current instrument state in the specified memory location.

Arguments

Type:	<NRf>
Range:	1 to 49. Non-integer values are rounded before execution
Type:	Common Command
Syntax:	*SAV<ws><NRf>
Example:	*SAV 25

Stored setting location 0 stores the factory defaults, and is a read-only location. Location 50 stores a copy of the current instrument setting, and it, too, is read-only.

## Instrument Control Commands

Instrument control commands are grouped into logical subsystems according to the SCPI instrument model. The commands are comprised of mnemonics indicating the subsystem to which the command belongs, and the hierarchy within that subsystem. When the command is to be referred to the Root node, it should be prefixed with a colon (:). Mnemonics appearing in square brackets [...] are optional. The '|' character is used to denote a choice of specifications. The '<ws>' is used to denote a white space character.

Model 2732: Two Channel 50 MHz Function/Arbitrary Waveform Generator  
**Programming and Interfacing**

---

### **SOURce and SOURce2 Subsystem**

The Source Subsystem controls the frequency, voltage, amplitude modulation and clock source. The command structure is as follows:

```
:SOURce
  :FREQuency
    [:CW|:FIXed] <numeric value>
  :PRATe <numeric value>
  :FUNction
    [:SHApe] SINusoid|SQUare|TRIangle||ARBitrary||PULSe
  : DCYClE ] <numeric value>
  :VOLTage
    [:AC]
      [:LEVel]
        [:IMMediate]
          [:AMPLitude] <numeric value>
          :OFFSet <numeric value>
  :REFerence
    [:SOURCE] INTernal |EXTernal
  :ROSCillator
    [:SOURCE] INTernal |EXTernal
  :AM
    [:STATe] <Boolean>
    :DEPTH <numeric value>
    :SHApe SINusoid|SQUare|TRIangle
    :FREQuency <numeric value>
    :SOURce INTernal |EXTernal
  :FM
    [:STATe] <Boolean>
    :DEVIation <numeric value>
    :SHApe SINusoid|SQUare|TRIangle
    :FREQuency <numeric value>
    :SOURce INTernal |EXTernal
  :FSK
    [:STATe] <Boolean>
    :LOWFrequency <numeric value>
    :HIFrequency <numeric value>
    :RATE <numeric value>
    :SOURce INTernal |EXTernal
  :SWEep
    :STATe <Boolean>
    :SPACing <LIN|LOG>
    :TIME <numeric value>
    :START <numeric value>
    :STOP <numeric value>
  :PHAsE
    [:ADjust] <numeric value >
  :PULSe
    :PERiod <numeric value >
    :WIDth <numeric value >
    :EDGE <numeric value >
    :RISe <numeric value >
    :FALL <numeric value >
```

**NOTE:** To access Channel 2 of the SOURce subsystem, replace :SOURce with :SOURce2 in all the examples listed.

### *Frequency*

:SOURce:FREQuency <frequency>

The frequency command controls the frequency of the output waveform.

#### Arguments

Type: Numeric.  
Units: MHz, KHz, Hz (default)  
Range: Dependent on the Point Rate and Wavelength.  
Fmax = 1/(12.5 nS \* Wavelength)  
Fmin = 1/(100S \* Wavelength)

Rounding: The value is rounded to 4 digits.

Command Types: Setting or Query

Setting Syntax: [:SOURce]:FREQuency[:CW]<ws><frequency>[units]  
[:SOURce]:FREQuency<ws>MINimum|MAXimum

Examples: :FREQ 5KHZ  
:FREQ 5E3  
:FREQ MAXIMUM  
:FREQ MIN

Query Syntax: [:SOURce]:FREQuency[:CW]?[<ws>MAXimum|MINimum]

Examples: :FREQ?  
:FREQ? MAX

Response: NR3

#### Considerations:

- 1) The MIN | MAX arguments should be used only in a Program Message that does NOT contain Program Message Units specifying Arbitrary Point Rate or Wavelength, since the MAXimum or MINimum value is calculated at the time the command is parsed.
- 2) The MIN and MAX arguments refer to currently settable minimum or maximum.
- 3) FIXEd is alias for CW.

**NOTE:** To access Channel 2 of the SOURce subsystem, replace :SOURce with :SOURce2 in all the examples listed.

*Amplitude*

:SOURce:VOLTage[:AMPLitude] <p-p amplitude>

The amplitude command is used to set the peak-to-peak amplitude of the output waveform. Note that the amplitude and the offset are limited by the relation

Output Voltage Range	Constraints of Amplitude + Offset
0.010 volt to 10.00 volts	$(V_{p-p})/2 +  \text{offset}  \leq 5 \text{ volts}$

Arguments

Type: Numeric  
 Units: V, mV, Vp-p, mVp-p  
 Range: 10mV to 10V  
 Rounding: 1mV - from 10mV to 999mV.  
 10mV - from 1V to 10V.  
 Command Type: Setting or Query

Setting Syntax: [:SOURce]:VOLTage:AMPLitude<ws><amplitude>[units]  
 [:SOURce]:VOLTage:AMPLitude<ws>MINimum|MAXimum

Examples: :VOLT:AMPL 2.5  
 :VOLT:AMPL 2.5V  
 :VOLT:AMPL MAX

Query Syntax: [:SOURce]:VOLTage:AMPLitude?  
 [<ws>MINimum|MAXimum]

Examples: :VOLT:AMPL?  
 :VOLT:AMPL? MAX

Response: NR2

Considerations:

- 1) The MAXimum amplitude is dependent on the offset.
- 2) The MAX and MIN arguments should not be used in a program message containing an OFFSet command, since these values are evaluated during parsing, based on the current value of the offset.

**NOTE:** To access Channel 2 of the SOURce subsystem, replace :SOURce with :SOURce2 in all the examples listed.



Model 2732: Two Channel 50 MHz Function/Arbitrary Waveform Generator  
**Programming and Interfacing**

---

*Offset*

:SOURce:VOLTage:OFFSet <offset>

The offset command is used to set the DC offset of the output waveform. Note that the amplitude and the offset are limited by the relation

Output Voltage Range	Constraints of Amplitude + Offset
0.010 volt to 10.00 volts	$(V_{p-p})/2 +  \text{offset}  \leq 5 \text{ volts}$

Arguments

Type: Numeric  
 Units: V, mV  
 Range: 10mV to 4.99V  
 Rounding: to 10mV  
 Command Type: Setting or Query

Setting Syntax: [:SOURce]:VOLTage:OFFSet<ws><offset>[units]  
 [:SOURce]:VOLTage:OFFSet<ws>MINimum|MAXimum

Examples: :VOLT:OFFS 2.5  
 :VOLT:OFFS 2.5V  
 :VOLT:OFFS MAX

Query Syntax: [:SOURce]:VOLTage:OFFSet?[<ws>MINimum|MAXimum]

Examples: :VOLT:OFFS?  
 :VOLT:OFFS? MAX

Response: NR2

Considerations:

- 1) The MAXimum offset is dependent on the amplitude.
- 2) The MAX and MIN arguments should not be used in a program message containing an AMPLitude command, since these values are evaluated during parsing, based on the current value of the amplitude.

**NOTE:** To access Channel 2 of the SOURce subsystem, replace :SOURce with :SOURce2 in all the examples listed.

### *Clock Reference Source*

:SOURce:REFerence:SOURce <clock source>

This command is used to select the source of the arbitrary waveform clock. This clock sets the arbitrary waveform point rate.

#### Arguments

Type: Character  
Options: INTernal, EXTernal  
Command Type: Setting or Query

#### Setting

Syntax: [:SOURce]: REFerence<ws><option>  
Examples: :REF INT  
:SOUR:REF EXT

#### Query

Syntax: [:SOURce]: REFerence?  
Response: INT|EXT

### *Function*

:SOURce:FUNcTION [:SHAPE]

The function command is used to set the type of waveform to be generated by the instrument.

Command Type: Setting or Query

Setting Syntax: [:SOURce]:FUNcTION[:SHAPE]<WS><OPTION>  
Examples: :FUNC SIN  
:FUNC ARB

Query Syntax: [:SOURce]:FUNcTION[:SHAPE]?  
Examples: :FUNC?  
Response: SIN|TRI|SQU|ARB|PUL

Considerations: The following functions are available:

*SINusoid, SQUare, TRIangle, ARBitary, PULse*

**NOTE:** To access Channel 2 of the SOURce subsystem, replace :SOURce with :SOURce2 in all the examples listed.

*Point Rate*

:SOURce:PRATe <point rate>

This command is used to set the point rate. It is coupled with the frequency of the waveform by the relation

$$\text{Frequency} = 1/(\text{Point Rate} * \text{Wavelength})$$

Thus changing the point rate will result in a change in frequency.

Arguments

Type: Numeric  
Units: S, mS, uS, nS  
Range: 8 nS to 100S  
Rounding: To 4 digits  
Command Type: Setting or Query

Setting Syntax: :SOURce:PRATe<ws><point rate>[units]  
:SOURce:PRATe<ws>MINimum|MAXimum

Examples: :ARB:PRAT 500NS

Query Syntax: :ARBitary:PRATe? [<ws>MINimum|MAXimum]  
Response: NR3

**NOTE:** To access Channel 2 of the SOURce subsystem, replace :SOURce with :SOURce2 in all the examples listed.

### ***AM Modulation***

The following commands control the AM modulation:

#### *AM STATE*

This command activates or deactivates AM modulation:

#### Arguments

Type: Boolean  
Command Type: Setting or Query

Setting Syntax: [:SOURce:]AM [:STATe]<ws>ON|1|OFF|0  
Examples: :SOURce:AM :STAT ON  
AM OFF

Query Syntax: [:SOURce:]AM[:STATe]?  
Response: 0|1

#### *AM DEPTH*

This command sets the AM modulation depth in %

#### Arguments

Type: Numeric  
Units: none (implied %)  
Range: 0 to 100  
Rounding: to integer  
Command Type: Setting or Query

Setting Syntax: :SOURce:AM:DEPT<ws><percent depth>  
:SOURce:AM:DEPT<ws>MINimum|MAXimum  
Examples: AM:DEPT 50

Query Syntax: AM:DEPT? [<ws>MINimum|MAXimum]  
Response: NR3

**NOTE:** To access Channel 2 of the SOURce subsystem, replace :SOURce with: SOURce2 in all the examples listed.

Model 2732: Two Channel 50 MHz Function/Arbitrary Waveform Generator  
**Programming and Interfacing**

---

*AM SHAPE*

This command selects the AM modulating waveform shape

Arguments

Type: Character  
Options: SINusoid, TRIangle, SQUare  
Command Type: Setting or Query

Setting Syntax: [:SOURce:]AM:SHAPE<ws><SIN|TRI|SQU>

Examples: [:SOURce:]AM:SHPE SIN  
AM:SHAPE TRI

Query Syntax: [:SOURce:]AM:SHAPE?

Response: SIN|TRI|SQU

*AM FREQUENCY*

This command sets the AM modulating waveform frequency

Arguments

Type: Numeric.  
Units: MHz, KHz, Hz (default)  
Range: Fmax = 20 KHz  
Fmin = 0.01 Hz  
Rounding: The value is rounded to 4 digits.  
Command Type: Setting or Query

Setting Syntax: [:SOURce:]AM:FREQUENCY<ws><frequency>[units]  
[:SOURce:]AM:FREQUENCY<ws>MINimum|MAXimum

Examples: AM:FREQ 5KHZ  
AM:FREQ 5E3  
AM:FREQ MAXIMUM  
AM:FREQ MIN

Query Syntax: [:SOURce:]AM:FREQUENCY? [<ws>MAXimum|MINimum]

Examples: AM:FREQ?  
AM:FREQ? MAX

Response: NR3

**NOTE:** To access Channel 2 of the SOURce subsystem, replace :SOURce with :SOURce2 in all the examples listed.

*AM SOURce*

This command selects the AM modulation source as either internal (then the above settings are effective) or external (and then the external waveform determines depth, shape and frequency of modulation).

Arguments

Type: Character  
Options: INTernal, EXTernal  
Command Type: Setting or Query

Setting Syntax: [ :SOURce:] AM:SOURce<ws><option>

Examples: AM:SOUR INT  
AM:SOUR EXT

Query Syntax: [ :SOURce]:AM:SOURce?

Response: INT|EXT

**NOTE:** To access Channel 2 of the SOURce subsystem, replace :SOURce with :SOURce2 in all the examples listed.

---

### *FM Modulation*

The following commands control the FM modulation:

#### *FM STATE*

This command activates or deactivates FM modulation:

#### Arguments

Type: Boolean  
Command Type: Setting or Query

Setting Syntax: [:SOURce:]FM[:STATe]<ws>ON|1|OFF|0

Examples: FM:STAT ON  
FM OFF

Query Syntax: [:SOURce:]FM[:STATe]?

Response: 0|1

#### *FM DEVIation*

This command sets the FM modulation deviation

#### Arguments

Type: Numeric.  
Units: MHz, KHz, Hz (default)  
Range: Dependent on the carrier frequency.  
Fmax = carrier frequency  
Fmin = 10  $\mu$ Hz

Rounding: The value is rounded to 4 digits.

Command Type: Setting or Query

Setting Syntax: [:SOURce]:FM:DEVIation<ws><frequency>[units]

[:SOURce]:FM:DEVIation<ws>MINimum|MAXimum

Examples: FM:DEV 5KHZ  
FM:DEV 5E3  
FM:DEV MAXIMUM  
FM:DEV MIN

Query Syntax: [:SOURce]:FM:DEVIation? [<ws>MAXimum|MINimum]

Examples: FM:DEV?  
FM:DEV? MAX

Response: NR3

Model 2732: Two Channel 50 MHz Function/Arbitrary Waveform Generator  
**Programming and Interfacing**

---

**NOTE:** To access Channel 2 of the SOURce subsystem, replace :SOURce with :SOURce2 in all the examples listed.



Model 2732: Two Channel 50 MHz Function/Arbitrary Waveform Generator  
**Programming and Interfacing**

---

*FM SHAPe*

This command selects the FM modulating waveform shape

Arguments

Type: Character  
Options: SINusoid, TRIangle, SQUare  
Command Type: Setting or Query

Setting Syntax: [:SOURce:]FM:SHAPe<ws><SIN|TRI|SQU>

Examples: [:SOURce:]FM:SHPE SIN  
FM:SHAPE TRI

Query Syntax: [:SOURce:]FM:SHAPe?

Response: SIN|TRI|SQU

*FM FREQuency*

This command sets the FM modulating waveform frequency

Arguments

Type: Numeric.  
Units: MHz, KHz, Hz (default)  
Range: Fmax = 20 KHz  
Fmin = 0.01 Hz  
Rounding: The value is rounded to 4 digits.  
Command Type: Setting or Query

Setting Syntax: [:SOURce:]FM:FREQuency<ws><frequency>[units]  
[:SOURce:]FM:FREQuency<ws>MINimum|MAXimum

Examples: FM:FREQ 5KHZ  
FM:FREQ 5E3  
FM:FREQ MAXIMUM  
FM:FREQ MIN

Query Syntax: [:SOURce:]FM:FREQuency? [<ws>MAXimum|MINimum]

Examples: FM:FREQ?  
FM:FREQ? MAX

Response: NR3

**NOTE:** To access Channel 2 of the SOURce subsystem, replace :SOURce with :SOURce2 in all the examples listed.

*FM SOURce*

This command selects the FM modulation source as either internal (then the above settings are effective) or external (and then the external waveform determines deviation, shape and frequency of modulation).

Arguments

Type: Character  
Options: INTernal, EXTernal  
Command Type: Setting or Query

Setting Syntax: [:SOURce:] FM:SOURce<ws><option>

Examples: FM:SOUR INT  
FM:SOUR EXT

Query Syntax: [:SOURce:]FM:SOURce?

Response: INT|EXT

*FSK modulation*

The following commands control the FSK modulation:

*FSK STATe*

This command activates or deactivates FSK modulation:

Arguments

Type: Boolean  
Command Type: Setting or Query

Setting Syntax: [:SOURce:]FSK[:STATe]<ws>ON|1|OFF|0

Examples: FSK:STAT ON  
FM OFF

Query Syntax: [:SOURce:]FSK[:STATe]?

Response: 0|1

**NOTE:** To access Channel 2 of the SOURce subsystem, replace :SOURce with :SOURce2 in all the examples listed.

*FSK LOWFrequency*

This command sets the lower of the two frequencies used in FSK modulation.

Arguments

Type: Numeric.  
Units: MHz, KHz, Hz (default)  
Range: The whole frequency range of the current function.  
Rounding: The value is rounded to 4 digits.  
Command Type: Setting or Query

Setting Syntax: [:SOURce:]FSK:LOWFrequency<ws><frequency>[units]  
[:SOURce:]FSK:LOWFrequency<ws>MINimum|MAXimum

Examples: FSK:LOWFrequency 5KHZ  
FSK:LOWF 5E3  
FSK:LOWF MAXIMUM  
FSK:LOWF MIN

Query Syntax: [:SOURce:]FSK:LOWFrequency? [<ws>MAXimum|MINimum]

Examples: FSK:LOWF?  
FSK:LOWF? MAX

Response: NR3

*FSK HIFrequency*

This command sets the higher of the two frequencies used in FSK modulation.

Arguments

Type: Numeric.  
Units: MHz, KHz, Hz (default)  
Range: The whole frequency range of the current function.  
Rounding: The value is rounded to 4 digits.  
Command Type: Setting or Query

Setting Syntax: [:SOURce:]FSK:HIFrequency<ws><frequency>[units]  
[:SOURce:]FSK:HIFrequency<ws>MINimum|MAXimum

Examples: FSK:HIFrequency 5KHZ  
FSK:HIF 5E3  
FSK:HIF MAXIMUM  
FSK:HIF MIN

Query Syntax: [:SOURce:]FSK:HIFrequency? [<ws>MAXimum|MINimum]

Examples: FSK:HIF?  
FSK:HIF? MAX

Response: NR3

**NOTE:** To access Channel 2 of the SOURce subsystem, replace :SOURce with :SOURce2 in all the examples listed.

*FSK RATE*

This command sets the rate of switching between the two frequencies of the modulation.

Arguments

Type: Numeric.  
Units: MHz, KHz, Hz (default)  
Range: Fmax = 1MHz  
Fmin = 0.01Hz  
Rounding: The value is rounded to 4 digits.  
Command Type: Setting or Query

Setting Syntax: [:SOURce]:FSK:RATE<ws><frequency>[units]  
[:SOURce]:FSK:RATE <ws>MINimum|MAXimum

Examples: FSK:RATE 5KHZ  
FSK:RATE 5E3  
FSK:RATE MAXIMUM  
FSK:RATE MIN

Query Syntax: [:SOURce]:FSK:RATE ?[<ws>MAXimum|MINimum]

Examples: FSK:RATE ?  
FSK:RATE ? MAX

Response: NR3

*FSK SOURce*

This command selects the FSK modulation source as either internal (then the above settings are effective) or external (and then the external waveform determines the frequency of modulation).

Arguments

Type: Character  
Options: INTernal, EXTernal  
Command Type: Setting or Query

Setting Syntax: [:SOURce:] FSK:SOURce<ws><option>

Examples: FSK:SOUR INT  
FSK:SOUR EXT

Query Syntax: [:SOURce]:FSK:SOURce?

Response: INT|EXT

**NOTE:** To access Channel 2 of the SOURce subsystem, replace :SOURce with :SOURce2 in all the examples listed.

### *Sweep Control*

The following commands control the sweep functionality:

#### *Sweep STATE*

This command activates or deactivates sweep:

##### Arguments

Type: Boolean  
Command Type: Setting or Query

Setting Syntax: [:SOURce:]SWEEP[:STATe]<ws>ON|1|OFF|0  
Examples: SWEEP:STAT ON  
SWEEP OFF

Query Syntax: [:SOURce:]SWEEP[:STATe]?  
Response: 0|1

#### *Sweep SPACing*

This command sets the sweep spacing as either LINear or LOGarithmic:

##### Arguments

Type: Character  
Options: LINear,LOGarithmic  
Command Type: Setting or Query

Setting Syntax: [:SOURce:]SWEEP:SPACing<ws><LIN|LOG>  
Examples: [:SOURce:] SWEEP:SPACing LIN  
SWEEP:SPAC LOG

Query Syntax: [:SOURce:] SWEEP:SPACing ?  
Response: LIN|LOG

**NOTE:** To access Channel 2 of the SOURce subsystem, replace :SOURce with :SOURce2 in all the examples listed.

Model 2732: Two Channel 50 MHz Function/Arbitrary Waveform Generator  
**Programming and Interfacing**

---

*Sweep TIME*

This command sets the time for one complete sweep:

Arguments

Type: Numeric  
Units: S, mS, uS, nS  
Range: 10mS to 500S  
Rounding: to 4 digits  
Command Type: Setting or Query

Setting Syntax: [:SOURce:]SWEEP:TIME<ws><time>[units]  
[:SOURce:]SWEEP:TIME<ws>MINimum|MAXimum

Examples: SWEEP:TIME 50MS

Query Syntax: [:SOURce:]SWEEP:TIME?[<ws>MINimum|MAXimum]

Response: NR3

*Sweep START*

This command sets the start frequency of the sweep:

Arguments

Type: Numeric.  
Units: MHz, KHz, Hz (default)  
Range: Dependent on the frequency range of the current function.  
Rounding: The value is rounded to 4 digits.  
Command Type: Setting or Query

Setting Syntax: [:SOURce:]SWEEP:START<ws><frequency>[units]  
[:SOURce:]SWEEP:START<ws>MINimum|MAXimum

Examples: SWEEP:START 5KHZ  
SWEEP:START 5E3  
SWEEP:START MAXIMUM  
SWEEP:START MIN

Query Syntax: [:SOURce:]SWEEP:START?[<ws>MAXimum|MINimum]

Examples: SWEEP:START ?  
SWEEP:START ? MAX

Response: NR3

**NOTE:** To access Channel 2 of the SOURce subsystem, replace :SOURce with :SOURce2 in all the examples listed.

*Sweep STOP*

This command sets the stop frequency of the sweep:

**Arguments**

Type: Numeric.  
Units: MHz, KHz, Hz (default)  
Range: Dependent on the frequency range of the current function.  
Rounding: The value is rounded to 4 digits.  
Command Type: Setting or Query

Setting Syntax: [ :SOURce: ]SWEEP:STOP<ws><frequency>[units]  
[ :SOURce: ]SWEEP:STOP<ws>MINimum|MAXimum

Examples: SWEEP:STOP 5KHZ  
SWEEP:STOP 5E3  
SWEEP:STOP MAXIMUM  
SWEEP:STOP MIN

Query Syntax: [ :SOURce: ]SWEEP:STOP? [<ws>MAXimum|MINimum]

Examples: SWEEP:STOP ?  
SWEEP:STOP ? MAX

Response: NR3

Model 2732: Two Channel 50 MHz Function/Arbitrary Waveform Generator  
**Programming and Interfacing**

---

**NOTE:** To access Channel 2 of the SOURce subsystem, replace :SOURce with :SOURce2 in all the examples listed.



### *Phase Control*

#### *PHASe adjust*

This command controls the phase adjustment

#### Arguments

Type: Numeric  
Units: one (degrees implied)  
Range: -180 to +180 (other values converted to this range)  
Rounding: to integer  
Command Type: Setting or Query

Setting Syntax: [:SOURce:]PHASe<ws><phase>  
[:SOURce:]PHASe<ws>MINimum|MAXimum

Examples: [:SOURce:]PHASe 500NS

Query Syntax: [:SOURce:]PHASe? [<ws>MINimum|MAXimum]  
Response: NR3

### *PULSe setting*

The following commands control the pulse function:  
Note the following pulse constraints:

Width < Period  
Width  $\geq$  Period \* 1 E-6  
Width  $\geq$  (Rise+Fall)  
Period > Width + (Rise + Fall)  
Rise  $\geq$  Width / 100 (or Rise = .01  $\mu$ s)  
Fall  $\geq$  Width / 100 (or Fall = .01  $\mu$ s)  
Rise > Period / 100,000 (or Rise = .01  $\mu$ s)  
Fall > Period / 100,000 (or Fall = .01  $\mu$ s)

#### *PULSe PERiod*

This command sets the pulse period to the specified value.  
NOTE: This also sets the pulse frequency.

#### Arguments

Type: Numeric  
Units: S, ms, us, ns  
Range: 40 ns-2000 s  
Rounding: 4 digits  
Command Type: Setting or Query

Setting Syntax: [:SOURce:] PULse: PERiod <ws><value>  
[:SOURce:] PULse: PERiod <ws>MINimum|MAXimum

Examples: [:SOURce:] PULse: PERiod 500NS

Query Syntax: [:SOURce:] PULse: PERiod? [<ws>MINimum|MAXimum]  
Response: NR3

**NOTE:** To access Channel 2 of the SOURce subsystem, replace :SOURce with :SOURce2 in all the examples listed.

Model 2732: Two Channel 50 MHz Function/Arbitrary Waveform Generator  
**Programming and Interfacing**

---

*PULSe WIDTH*

This command pulse width to the specified value.

Arguments

Type: Numeric  
Units: s, ms, us, ns  
Range: 20 ns minimum; maximum defined by period and transition  
(see constraints on pg 5-47)  
Rounding: 4 digits  
Command Type: Setting or Query

Setting Syntax: [:SOURce:]PULse:WIDth<ws>< value >  
[:SOURce:] PULse:WIDth <ws>MINimum|MAXimum

Examples: [:SOURce:] PULse:WIDth 500NS

Query Syntax: [:SOURce:] PULse: WIDth? [<ws>MINimum|MAXimum]  
Response: NR3

*PULSe EDGe*

This command sets both rising and falling edge of the pulse to the specified value.

Arguments

Type: Numeric  
Units: s, ms, us, ns  
Range: 100 ns minimum; maximum defined by period and width (see  
constraints on pg 5-47)  
Rounding: 4 digits  
Command Type: Setting or Query

Setting Syntax: [:SOURce:] PULse:EDGe <ws>< value >  
[:SOURce:] PULse:EDGe <ws>MINimum|MAXimum

Examples: [:SOURce:] PULse:EDGe 500NS

Query Syntax: [:SOURce:] PULse:EDGe? [<ws>MINimum|MAXimum]  
Response: NR3

**NOTE:** To access Channel 2 of the SOURce subsystem, replace :SOURce with :SOURce2 in all the examples listed.

*PULSe RISE*

This command sets rising edge of the pulse to the specified value.

Arguments

Type: Numeric  
Units: s, ms, us, ns  
Range: 100 nS minimum; maximum defined by period and width  
(see constraints on pg 5-47)  
Rounding: 4 digits  
Command Type: Setting or Query

Setting Syntax: [:SOURce:] PULse:RISe <ws><phase>  
[:SOURce:] PULse:RISe <ws>MINimum|MAXimum

Examples: [:SOURce:] PULse:RISe 500NS

Query Syntax: [:SOURce:] PULse:RISe?[<ws>MINimum|MAXimum]  
Response: NR3

*PULSe FALI*

This command sets falling edge of the pulse to the specified value.

Arguments

Type: Numeric  
Units: s, ms,  $\mu$ s, ns  
Range: 100 nS minimum; maximum defined by period and width  
(see constraints on pg 5-47)  
Rounding: 4 digits  
Command Type: Setting or Query

Setting Syntax: [:SOURce:] PULse:FALI <ws><phase>  
[:SOURce:] PULse:FALI <ws>MINimum|MAXimum

Examples: [:SOURce:] PULse:FALI 500NS

Query Syntax: [:SOURce:] PULse:FALI?[<ws>MINimum|MAXimum]  
Response: NR3

**NOTE:** To access Channel 2 of the SOURce subsystem, replace :SOURce with :SOURce2 in all the examples listed.

*Duty Cycle*

:SOURce:DCYCLE <duty cycle value<

This command is used to set the duty-cycle of the square wave or the symmetry of triangular wave. The value is given in percent .

Arguments

Type: Numeric  
Units: None (percent implied)  
Range: 20 to 80  
Rounding: to integer  
Command Type: Setting or Query

Setting Syntax: :SOURce: DCYCLE <ws><duty cycle value<  
:SOURce: DCYCLE <ws>MINimum|MAXimum

Query Syntax: :SOURce: DCYCLE?[<ws>MINimum|MAXimum]  
Response: NR3

***OUTPut Subsystem***

The Output Subsystem controls characteristics of the source's output. Included in this subsystem are the State and Summing commands. The Channel 2 subsystem can be accessed using the statement *OUTPut2*, and The command structure is as follows:

:OUTPut  
[:STATe] <Boolean>  
:SUMming <Boolean>

*Output State*

:OUTPut [:STATe] <state 0,1>

This command controls whether the output is ON or OFF.

Arguments

Type: Boolean  
Command Type: Setting or Query

Setting Syntax: :OUTPut[:STATe]<ws>ON|1|OFF|0  
Examples: :OUTP:STAT ON  
:OUTP OFF

Query Syntax: :OUTPut[:STATe]?  
Response: 0|1

Model 2732: Two Channel 50 MHz Function/Arbitrary Waveform Generator  
**Programming and Interfacing**

---

**NOTE:** To access Channel 2 of the OUTPut subsystem, replace :OUTPut with :OUTPut2.

### *Output Summing*

:OUTPut :SUMming <state 0,1>

This command controls whether the summing is ON or OFF.

#### Arguments

Type: Boolean  
Command Type: Setting or Query

Setting Syntax: :OUTPut:SUMming<ws>ON|1|OFF|0

Examples: :OUTP:SUM ON  
:OUTP:SUM OFF

Query Syntax: :OUTPut:SUMming?

Response: 0|1

### ***Trigger Subsystem***

The Trigger Subsystem is used to control the waveform triggering. Channel 2 triggering can be initiated using the subsystem TRIGger2. The command structure is as follows:

```
:TRIGger
:MODE CONTinuous|TRIGger|GATE|BURSt
:BURSt <numeric value>
:SOURce <MANual|INTernal|EXTernal|BUS
:TIMer <numeric value>
```

### *Trigger Mode*

:TRIGger:MODE <trigger mode>

This command is used to set the trigger mode. It is not a standard SCPI command.

#### Arguments

Type: Character  
Options: CONTinuous

TRIGger

GATE

BURSt

Command Type: Setting or Query

Setting Syntax: :TRIGger:MODE<ws><option>

Examples: :TRIG:MODE CONT  
:TRIG:MODE BURSt

Query Syntax: :TRIGger:MODE?

Response: CONT|TRIG|GATE|BURSt

**NOTE:** To access Channel 2 of the TRIGger subsystem, replace :TRIGger with :TRIGger2.

Model 2732: Two Channel 50 MHz Function/Arbitrary Waveform Generator  
**Programming and Interfacing**

---

*Trigger Source*

:TRIGger:SOURce <trigger source>

This command is used to select the trigger source, for use in the Trigger, Gate and Burst trigger modes.

Arguments

Type: Character  
Options: MANual - Front panel MAN key  
          BUS - GPIB trigger (GET or \*TRG)  
          INTernal - Internal trigger  
          EXTernal - External trigger  
Command Type: Setting or Query  
Setting Syntax: :TRIGger:SOURce<ws><option>  
Examples: :TRIG:SOUR BUS  
          :TRIG:SOUR INT  
Query Syntax: :TRIGger:SOURce?  
Response: MAN|BUS|INT|EXT

*Burst Count*

:TRIGger:BURSt <burst count>

Used to set the number of cycles to be output in the BURST mode. It is not a standard SCPI command.

Arguments

Type: Numeric  
Range: 1 to 999999  
Rounding: to integer value  
Command Type: Setting or Query  
Setting Syntax :TRIGger:BURSt<ws><value>  
Examples :TRIG:BURS 100  
          :TRIG:BURS MAXIMUM  
Query Syntax: :TRIGger:BURSt? [<ws>MAXimum|MINimum]  
Response: NR1  
Examples: :TRIG:BURST?  
          :TRIG:BURS? MAX

**NOTE:** To access Channel 2 of the TRIGger subsystem, replace :TRIGger with :TRIGger2.

*Internal Trigger Rate*

:TRIGger:TIMer <trigger rate>

Sets the rate of the internal trigger.

Arguments

Type: Numeric  
Units: s, ms, us, ns  
Range: 1E-6S to 100S  
Rounding: to 4 digits  
Command Type: Setting or Query

Setting Syntax: :TRIGger:TIMer<ws><value>[units]  
:TRIGger:TIMer<ws>MINimum|MAXimum

Examples: :TRIG:TIM 10E-6  
:TRIG:TIM MIN

Query Syntax: :TRIGger:TIMer?[<ws>MINimum|MAXimum]

Response: NR3

Examples: :TRIG:TIM?  
:TRIG:TIM? MIN

**NOTE:** To access Channel 2 of the TRIGger subsystem, replace :TRIGger with :TRIGger2

***Arbitrary Subsystem***

The Arbitrary subsystem is not part of the SCPI standard. It was developed to suit the needs of the instrument. Following the same mnemonics of earlier subsystems, Channel 2 arbitrary subsystems can be accessed using the ARBitrary2 command. Within this subsystem are found commands to:

- 1) Control the point rate, start address, wavelength, marker address, and synchronization pulse address;
- 2) Set values of the arbitrary waveform, either discretely or using predefined, copy or draw functions;
- 3) Protect an area of waveform memory;
- 4) Set the state of the automatic update and increment features;
- 5) Update the waveform.

**NOTE:** To access Channel 2 of the ARBitrary subsystem, replace :ARBitrary with :ARBitrary2 in all the examples listed.



The following shows the structure of the ARbitrary subsystem:

```

:ARbitrary
  :PRATe <numeric value>
  :ADDReSS <numeric value>
  :DATA <numeric value>|<arbitrary block>
  :DRAW <numeric value>,<numeric value>
  :CLEAr <numeric value>,<numeric value>
  :COpy <NRf>,<NRf>,<NRf>
  :PROTeCt
    [ :RANGe ] <numeric value>,<numeric value>
    :STATe <Boolean>
  :PREDeFined <shape>,<start address>,<length>,<scale>
  :START <numeric value>
  :LENGth <numeric value>
  :MARKer
    [ :ADDReSS ] <numeric value>
    :STATe <Boolean>
    :LENGth <numeric value>
  :SAVe
  
```

#### *Point Execution Rate*

ARbitrary:PRATe <point rate>

This command is used to set the point execution rate. It is coupled with the frequency of the waveform by the relation:

$$\text{Frequency} = 1/(\text{Point Rate} * \text{Wavelength})$$

Thus changing the point rate will result in a change in frequency.

#### Arguments

Type:	Numeric
Units:	s, ms, us, ns
Range:	8ns to 100s
Rounding:	to 4 digits
Command Type:	Setting or Query

Setting Syntax: :ARbitrary:PRATe<ws><point rate>[units]  
 :ARbitrary:PRATe<ws>MINimum|MAXimum

Examples: :ARB:PRAT 100NS

Query Syntax: :ARbitrary:PRATe? [<ws>MINimum|MAXimum]

Response: NR3

**NOTE:** To access Channel 2 of the ARbitrary subsystem, replace :ARbitrary with :ARbitrary2 in all the examples listed.

Model 2732: Two Channel 50 MHz Function/Arbitrary Waveform Generator  
**Programming and Interfacing**

---

*Address*

:ARbitrary:ADDRESS <address>

This command sets the current address of the waveform. It is used to determine to where arbitrary data are to be written.

Arguments

Type: Numeric  
Range: 1 to 4,000,000  
Rounding: to integer value  
Command Type: Setting or Query

Setting Syntax: :ARbitrary:ADDRESS<ws><address>  
:ARbitrary:ADDRESS<ws>MINimum|MAXimum

Examples: :ARB:ADDR 100

Query Syntax: :ARbitrary:ADDRESS? [<ws>MINimum|MAXimum]

Response: NR1

*Data*

:ARbitrary:DATA <data>

This command is used to set the values of the waveform.

Arguments

Type: Numeric.  
Definite form arbitrary block.  
Indefinite form arbitrary block  
Numeric Range: -8191 to 8191 ASCII  
Rounding: Must be round to a whole integer  
Binary Range: 001H to 3FFFH BINARY  
Command Type: Setting or Query

Setting Syntax:

Numeric: :ARbitrary:DATA<ws><numeric>{[,<numeric>]}  
Example :ARB:DATA 100,200,1000,2000,-2000

Arbitrary Block: :ARbitrary:DATA<ws># <arb block data>  
See the section on Block Transfer

Examples

Definite: :ARB:DATA #14\x8\x64\x8\xC8  
'\x' indicates that the values are Hexadecimal.

Indefinite: :ARB:DATA #0\x8\x64\x8\xC8\xa^EOI

Query Syntax: :ARbitrary:DATA?<ws><number of points>, BINary|ASCii

Response: Using the BINary option, data is returned in indefinite arbitrary block form.

Using the ASCii option, data is returned in decimal numeric form.

**NOTE:** To access Channel 2 of the ARbitrary subsystem, replace :ARbitrary with :ARbitrary2 in all the examples listed.

Considerations:

- 1) Data cannot be written to protected memory. In binary form, each data point consists of two bytes. The high byte must precede the low byte.

*Line Draw*

:ARbitrary:DRAW <start address>,<end address>

This command is used to generate a straight line between two points in the arbitrary waveform memory.

Arguments

Type: Numeric.  
Range: 1 to 4,000,000  
Rounding: to integer value  
Command Type: Setting only

Setting Syntax: :ARbitrary:DRAW<ws><start address>, <end address>

Example: :ARB:DRAW 1,1000

Considerations:

- 1) The value of the data at the start and end points must first be set by the user, using the :ARB:DATA command.
- 2) The range of the straight line cannot overlap with protected memory.
- 3) The end address must be greater than the start address.

*Clear*

:ARbitrary:CLEAr <start address>,<end address>

This command is used to clear all or a portion of waveform memory. The memory is set to the value zero.

Arguments

Type: Numeric.  
Numeric Range: 1 to 4,000,000  
Rounding: to integer value  
Command Type: Setting only.

Setting Syntax: :ARbitrary:CLEAr<ws><start address>, <end address>

Examples: :ARB:CLE 1,1000

Considerations:

- 1) The clear range cannot overlap with protected memory.
- 2) The end address must be greater than the start address.

**NOTE:** To access Channel 2 of the ARbitrary subsystem, replace :ARbitrary with :ARbitrary2 in all the examples listed.

*Copy*

:ARbitrary:COpy <start address>,<length>,<destination address>

This command is used to copy a section of the waveform to a different location in waveform memory.

Arguments

Type: NRf  
Range: 1 to 4,000,000  
Rounding: to integer value  
Command Type: Setting only

Setting Syntax: :ARbitrary:COpy<ws><start>,<length>,<destination>

Example: :ARB:COpy 1,1000,1001

Considerations:

- 1) The destination range cannot overlap with protected memory.
- 2) The destination range cannot overlap with the source range.
- 3) The destination end address may not exceed the maximum address:

Destination address + Length-1 <= 3,999,999

*Memory Protection Range*

:ARbitrary:PROTECT [:RANGe] <start address>,<end address>

This command is used to define a range of arbitrary waveform memory to be write-protected. The protection is effective only if the PROTECT:STATE is ON.

Arguments

Type: Numeric.  
Numeric Range: 1 to 4,000,000  
Rounding: to integer value.  
Command Type: Setting or Query

Setting Syntax: :ARbitrary:PROTECT[:RANGe]<ws><start>,<end>

Examples: :ARB:PROT 1,1E3

Query Syntax: :ARbitrary:PROTECT[:RANGe]?

Response: <protect start>,<protect end> in NR1 format.

**NOTE:** To access Channel 2 of the ARbitrary subsystem, replace :ARbitrary with :ARbitrary2 in all the examples listed.

*Memory Protection State*

:ARbitrary:PROTECT:STATE <Boolean>

This command is used to enable or disable arbitrary waveform write-protection.

Arguments

Type: Boolean

Command Type: Setting or Query

Setting Syntax: :ARbitrary:PROTECT:STATE<ws>ON|1|OFF|0

Example: :ARB:PROT:STAT ON

Query Syntax: :ARbitrary:PROTECT:STATE?

Response: 0|1

**NOTE:** To access Channel 2 of the ARbitrary subsystem, replace :ARbitrary with :ARbitrary2 in all the examples listed.

Model 2732: Two Channel 50 MHz Function/Arbitrary Waveform Generator  
**Programming and Interfacing**

---

Predefined Waveforms

:ARB:PRED <shape>,<start address>,<length>,<scale>

This command is used to load the waveform memory with a specific type of waveform.

Arguments

Shape

Type: Character  
Options: SINusoid  
SQUare  
TRIangle  
NOISe (Pseudo-Random Noise)  
ANOise (Noise added to the current waveform)  
URAMP  
DRAMP  
SINXX  
EXPUP  
EXPDN  
GAUS

Start Address

Type: Numeric. The MIN and MAX forms both set the address to 1  
Range: 1 to 4,000,000  
Rounding: to integer value

Length

Type: Numeric.

Range

SIN: 16 to 65,536; divisible by 4  
SQU: 2 to 65,536; divisible by 2  
TRI: 16 to 65,536; divisible by 4  
NOIS: 16 to 65,536  
ANO: 16 to 65,536  
URAMP: 16 to 65,536  
DRAMP: 16 to 65,536  
SINXX: 16 to 65,536  
EXPUP: 16 to 65,536  
EXPDN: 16 to 65,536  
GAUS: 16 to 65,536

Rounding: to integer value.

Scale

Type: Numeric. MIN sets the scale to 1; MAX sets the scale to 100  
Range: 1 to 100 (See considerations)  
Rounding; to integer value.  
Command Type: Setting only

Setting Syntax: :ARBitrary:PREDefined<ws> <shape>, <start>, <length>,<scale>  
Examples: :ARB:PRED SIN,1,1e3,100

**NOTE:** To access Channel 2 of the ARBitrary subsystem, replace :ARBitrary with :ARBitrary2 in all the examples listed.

Model 2732: Two Channel 50 MHz Function/Arbitrary Waveform Generator  
**Programming and Interfacing**

---

Considerations:

- 1) The start address and the length must meet the specification that.  
 $\text{Start address} + \text{Length} - 1 \leq 3,999,999$
- 2) The 'scale' refers to the scaling of the waveform as a percentage of full scale. A scale of 100% will, under the correct conditions, generate a waveform whose data values range from -8191 to +8191. These 'correct conditions' are set by the 'offset' value. This offset is the value of the data at the start address, and determines the maximum scale settable. The following table shows the data values required in order to achieve maximum scale.

SHAPE	DATA
SIN	0
SQU	0
TRI	0
NOIS	0

*Start Address*

:ARbitrary:START <start address>

This command sets the start address of the waveform to be run.

Arguments

Type: Numeric  
 Range: 1 to 3,999,999  
 Rounding: to integer value  
 Command Type: Setting or Query

Setting Syntax: :ARbitrary:START<ws><start address>  
 :ARbitrary:START<ws>MINimum|MAXimum

Example: :ARB:STAR 100

Query Syntax: :ARbitrary:START? [<ws>MINimum|MAXimum]

Examples: :ARB:START?  
 :ARB:STAR? MIN

Response: NR1

Considerations:

1. The start address and length must meet the condition:  
 $\text{Start Address} + \text{Length} - 1 \leq 3,999,999$

**NOTE:** To access Channel 2 of the ARbitrary subsystem, replace :ARbitrary with :ARbitrary2 in all the examples listed.

*Wavelength*

:ARbitrary:LENGth <length>

This command sets the length of the waveform being run.

Arguments

Type: Numeric  
Range: 2 to 3,999,999  
Rounding: to integer value  
Command Type: Setting or Query

Setting Syntax: :ARbitrary:LENGth<ws><length>  
:ARbitrary:LENGth<ws>MINimum|MAXimum

Example: :ARB:LENG 1E3

Query Syntax: :ARbitrary:LENGth? [<ws>MINimum|MAXimum]

Example: :ARB:LENG?

Response: NR1

Considerations:

- 1) Changing the wavelength will change either the frequency.
- 2) The minimum wavelength is 2.

*Marker Address*

:ARbitrary:MARKer [:ADDRESS] <marker address>

This command is used to set the address of the marker.

Arguments

Type: Numeric.  
Range: 1 to 3,999,999  
Rounding: to integer values

Setting Syntax: :ARbitrary:MARKer[:ADDRESS]<ws><marker address>

Examples: :ARB:MARK 45

Query Syntax: :ARbitrary:MARKer[:ADDRESS]?

Example: :ARB:MARK?

Response: Marker address in NR1 format.

Considerations:

- 1) The marker is only output if it's address is within the range of addresses currently being run.

**NOTE:** To access Channel 2 of the ARbitrary subsystem, replace :ARbitrary with :ARbitrary2 in all the examples listed.



*Marker Length*

:ARbitrary:MARKer:LENGth <numeric value>

This command is used to set the marker length. The marker length is specified by appending a numeric value, to the MARKer keyword.

Arguments

Type: Numeric  
Command Type: Setting or Query

Setting Syntax: :ARbitrary:MARKer:LENGth<ws><length>

Example: :ARB:MARK:LENG 5

Query Syntax: :ARbitrary:MARKer:LENGth?

Response: NR1

*Marker State*

:ARbitrary:MARKer:STATe <Boolean>

This command is used to enable or disable the marker.

Arguments

Type: Boolean  
Command Type: Setting or Query

Setting Syntax: :ARbitrary:MARKer:STATe<ws>ON|1|OFF|0

Query Syntax: :ARbitrary:MARKer:STATe?

Response: 0|1

*Save*

:ARbitrary:SAVe

This command is used to save all unsaved arbitrary waveform data into non-volatile memory.

Arguments

Type: none  
Command Type: Setting only

Setting Syntax: :ARbitrary: SAVe

**NOTE:** To access Channel 2 of the ARbitrary subsystem, replace :ARbitrary with :ARbitrary2 in all the examples listed.

### ***Status Subsystem***

This subsystem controls the SCPI-defined status reporting structures, which are the QUESTIONable and OPERATION status registers, and the error/event queue. The OPERATION status registers are mandated by SCPI, and so are implemented, but are not used by the hardware. No status is ever reported through them, and they are not detailed in this manual. The following shows STATUS structure used:

```
:STATus
  :PRESet
  :QUEue
    [:NEXT]?
    :ENABle
  :QUEStionable
    :CONDition?
    :PTRansition <NRf>
    :NTRansition <NRf>
    :EVENT?
    :ENABle <NRf>
```

#### *Status Preset*

:STATus:PRESet

This command is used to set certain status values to defined values.

- a) The OPERATION and QUESTIONable enable registers are cleared.
- b) The Positive transition filters are set to 32767.
- c) The Negative transition filters are set to 0.
- d) Only errors in the range (-440:-100) are enabled to be reported in the event queue.

Command Type:     Setting only

Setting Syntax:     :STATus:PRESet

*Error Queue Read*

:STATus:QUEue?

This query returns the first entry in the error queue, and removes that entry from the queue. Its function is identical to that of the :SYSTem:ERRor? query.

Command Type: Query only

Query Syntax: :STATus:QUEue[:NEXT]?

Response: <Error number>, "<error description>"

*Error Queue Enable*

:STATus:QUEue:ENABle

This command is used to enable individual errors to be placed in the queue when they occur. Those errors not specified in the :ENABle command are disabled from being reported in the error queue. Errors and events enabled to be reported at power on depends on the Power on Status Clear status (set with the \*PSC common command). If PSC is set, the status is cleared on power on, and the range of errors enabled is as set by the STATus:PRESet command, ie -440 to -100. If PSC is cleared, the status is not cleared on power on, and the errors and events enabled are those that were enabled before the last power down.

Type: Expression

The expression data takes the form

(NRf|<event range>[{,NRf|<event range>}])

where NRf represents an error number. Entries are rounded to integer values.

An <event range> is defined as

NRf:NRf

The first number in a range MUST be less than the second.

Up to 6 ranges may be specified using one :ENABle command, representing the 6 ranges of errors/events. The ranges are then separated from each other by Program Data Separators (comma). The entire expression must be enclosed in parentheses(...).

Command Type: Setting or Query

Setting Syntax: :STATus:QUEue:ENABle<ws><expression>

Example: :STAT:QUE:ENAB (-440:-410,-258:-220,402,-110)

Query Syntax: :STATus:QUEue:ENABle?

Response: (NRf|<event range>[{,NRf|event range>}])

*Questionable Status*

The Questionable status data structure is used to alert the user to instrument conditions that affect the signal quality. Two types of conditions are defined. These are:

- 1) Frequency - Trigger rate conflict.
- 2) Output overload condition.

Each condition is reported separately for each channel. Thus, a total of four conditions may be reported.

The data structure is comprised of five 16-Bit registers. Each bit represents a different status condition. Bits 9 and 11 are used as follows:

- Bit 9: Frequency - trigger rate conflict.
- Bit 11: Output overload.

The existence of these conditions is indicated in the CONDition register. Bit 3 of the status byte is used to indicate the occurrence of a questionable status condition. The conditions cause this bit to be set depending on the values of the other four registers.

The positive transition filter enables a bit in the event register to be set when a condition changes from false to true. The negative transition register enables a bit in the event register to be set when a condition changes from true to false. In order for the bit in the event register to be set, the corresponding bit in the transition register must be set.

Bit 3 in the status byte will be set if a bit in the event register is set while the corresponding bit in the enable register is set.

*Questionable Condition*

:STATus:QUEstionable:CONDition?

This query is used to read the condition register.

Command Type:      Query only

Query Syntax:        :STATus:QUES:COND?

Response:            NR1

*Positive Transition Filter*

:STAT:QUES:PTR

This command is used to set and query the value of the positive transition filter.

Arguments

Type: NRf

Range: 0 to 131,072. Non-integer arguments are rounded before execution.

Command Type: Setting or Query

Setting Syntax: :STAT:QUES:PTR<ws><NRf>

Examples: :STAT:QUES:PTR 2048

Query Syntax: :STAT:QUES:PTR?

Response: NR1

*Negative Transition Filter*

:STAT:QUES:NTR

This command is used to set and query the value of the negative transition filter.

Arguments

Type: NRf

Range: 0 to 131,072. Non-integer arguments are rounded before execution

Command Type: Setting or Query

Setting Syntax: :STAT:QUES:NTR<ws><NRf>

Examples: :STAT:QUES:NTR 2048

Query Syntax: :STAT:QUES:NTR?

Response: NR1

*Event Register*

:STAT:QUES:EVENT?

This query is used to read the event register. Reading the register clears it.

Command Type:      Query only

Query Syntax:        :STATus:QUES:EVEN?

Response:            NR1

*Event Enable Register*

:STAT:QUES:ENABLE

This command is used to set and query the value of the enable register.

Arguments

Type:                NRf

Range:               0 to 131,072. Non integer arguments are rounded before execution.

Command Type:      Setting or Query

Setting Syntax:     :STAT:QUES:ENAB<ws><NRf>

Examples:            :STAT:QUES:ENAB 2048

Query Syntax:        :STAT:QUES:ENAB?

Response:            NR1

### ***System Subsystem***

The SYSTem subsystem collects the functions that are not related to instrument performance. The functions implemented in the AWG are security, GPIB address changing, error queue reading, SCPI version reading, and power-on buffer setting (not SCPI-defined). The command structure is as follows:

```
:SYSTem
  :COMMunicate
    :GPIB
      :ADDRess <numeric value>
    :ERRor?
    :VERSion?
    :SECurity
      [:STATe] <Boolean>
    :POBuffer <numeric value>
```

#### *GPIB Address Change*

:SYSTem:COMMunicate:GPIB:ADDRess

This command is used to set the GPIB address.

#### Arguments

Type:	Numeric
Range:	0 to 31
Rounding:	to integer value
Command Type:	Setting or Query

#### Setting Syntax:

:SYSTem:COMMunicate:GPIB:ADDRess<ws><address>|MINimum|MAXimum

Example: :SYST:COMM:GPIB:ADDR 20

Query Syntax: :SYSTem:COMMunicate:GPIB:ADDRess? [<ws>MINimum|MAXimum]

Response: <address> in NR1 format

#### Considerations:

- 1) Setting the address to 31 puts the instrument in the off-bus state.
- 2) Using the MAX option sets the address to 30, not 31.

Default Power-on is address 9.

*Error Queue Reading*

:SYSTem:ERRor?

This query returns the first entry in the error queue, and removes that entry from the queue. It's function is identical to that of the :STATus:QUEue:NEXT? query.

Command Type: Query only

Query Syntax: :SYSTem:ERRor?

Response: <Error number>, "<error description>"

*SCPI Version*

:SYSTem:VERSion?

This query is used to read the SCPI version to which the instrument complies.

Command Type: Query only

Query Syntax: :SYSTem:VERSion?

Response: 1992.0 (NR2 format)

*Security*

:SYSTem:SECurity[:STATe] <Boolean>

This command enables the instrument memory to be cleared. The stored settings and the arbitrary waveform memory are cleared when the Security state is changed from ON to OFF. The instrument state is returned to the factory power-on default.

Arguments

Type: Boolean

Command Type: Setting or Query

Setting Syntax: :SYSTem:SECurity[:STATe]<ws>ON|1|OFF|0

Examples: :SYST:SEC ON  
:SYST:SEC OFF

Query Syntax: :SYSTem:SECurity[:STATe]?

Response: 0|1



*Power-on Buffer*

`:SYSTEM:POBuffer <buffer number>`

This command is used to set the Power On Buffer setting. The instrument will power-on with the setting stored in that buffer.

Arguments

Type: Numeric  
Range: 0 to 49  
Rounding: to integer value  
Command Type: Setting or Query

Setting Syntax: `:SYSTEM:POBuffer<ws><buffer>|MINimum|MAXimum`

Example: `:SYST:POB 99`

Query Syntax: `:SYSTEM:POBuffer? [<ws>MINimum|MAXimum]`

Response: Power-on buffer in NR1 format

## IEEE 488.1 INTERFACE MESSAGES

### *GET - Group Execute Trigger*

The GET is used by the AWG as a trigger when it is in either the TRIGGER, GATE or BURST modes, with the trigger source set to BUS. It has the same effect as the \*TRG common command.

### *DCL - Device Clear*

In response to the DCL, the AWG does the following:

- a) Clears the input buffer and the output queue.
- b) Resets the Message Processing Functions.

### *SDC - Selected Device Clear*

The response is as for the DCL message, when device is addressed to listen.

### *LLO - Local Lockout*

Sending LLO when device is addressed to listen and controller is asserting the REN line will put the device into "Remote with Lock out" state, locking out the front panel.

Model 2732: Two Channel 50 MHz Function/Arbitrary Waveform Generator  
**Programming and Interfacing**

SCPI Command Trees

*Figure 5.3 - Root Node Tree*

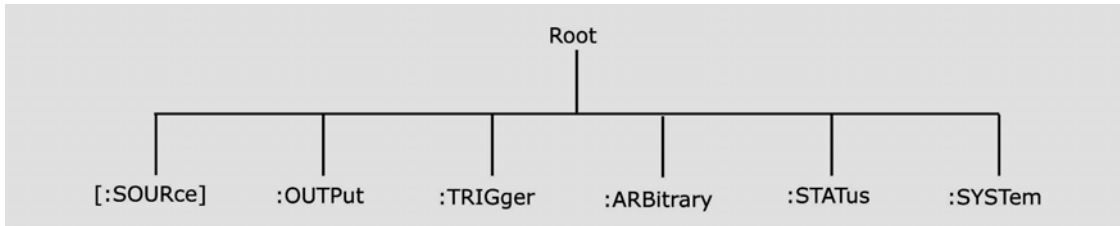

For Channel 2 Root Node's Use: SOUR2, OUTP2, TRIG2, and ARB2

*Figure 5.4 - :SOURce Subsystem Tree*

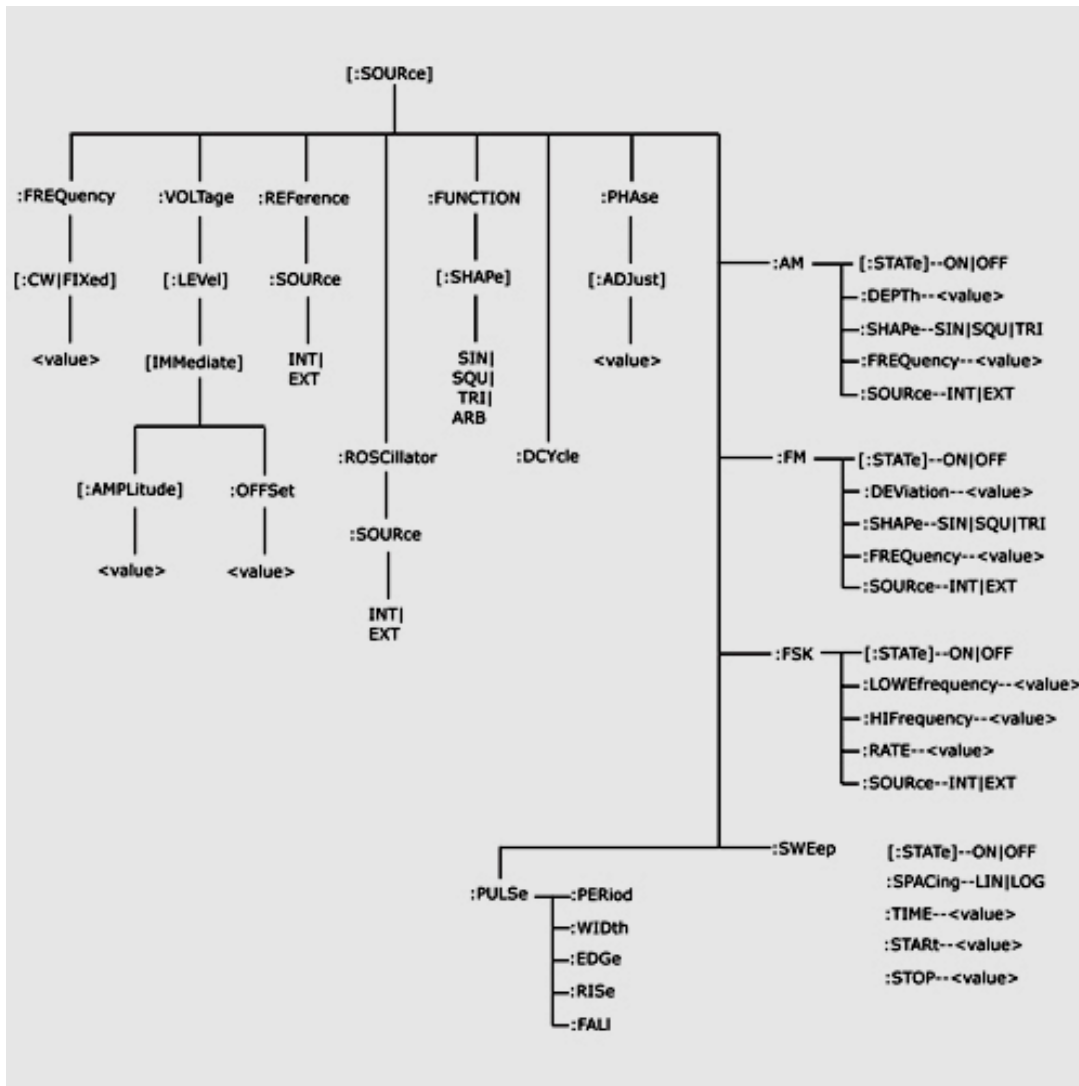

To Initialize Channel 2 Subsystems Use: SOUR2 or SOURce2

*Figure 5.5 - :OUTPut Subsystem Tree*

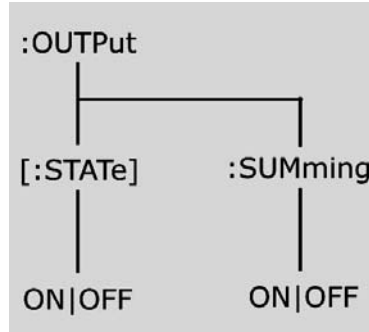

For Channel 2 Use: OUTP2 or OUTPut2

*Figure 5.6 - :TRIGger Subsystem Tree*

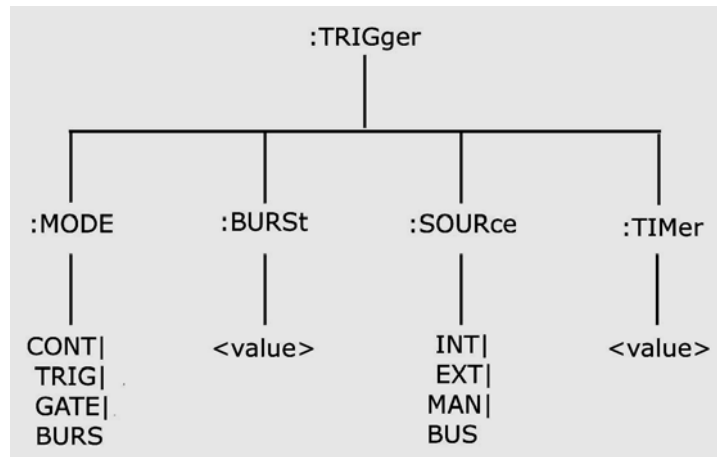

For Channel 2 Use: TRIG2 or TRIGger2

Figure 5.7 - :ARbitrary Subsystem Tree

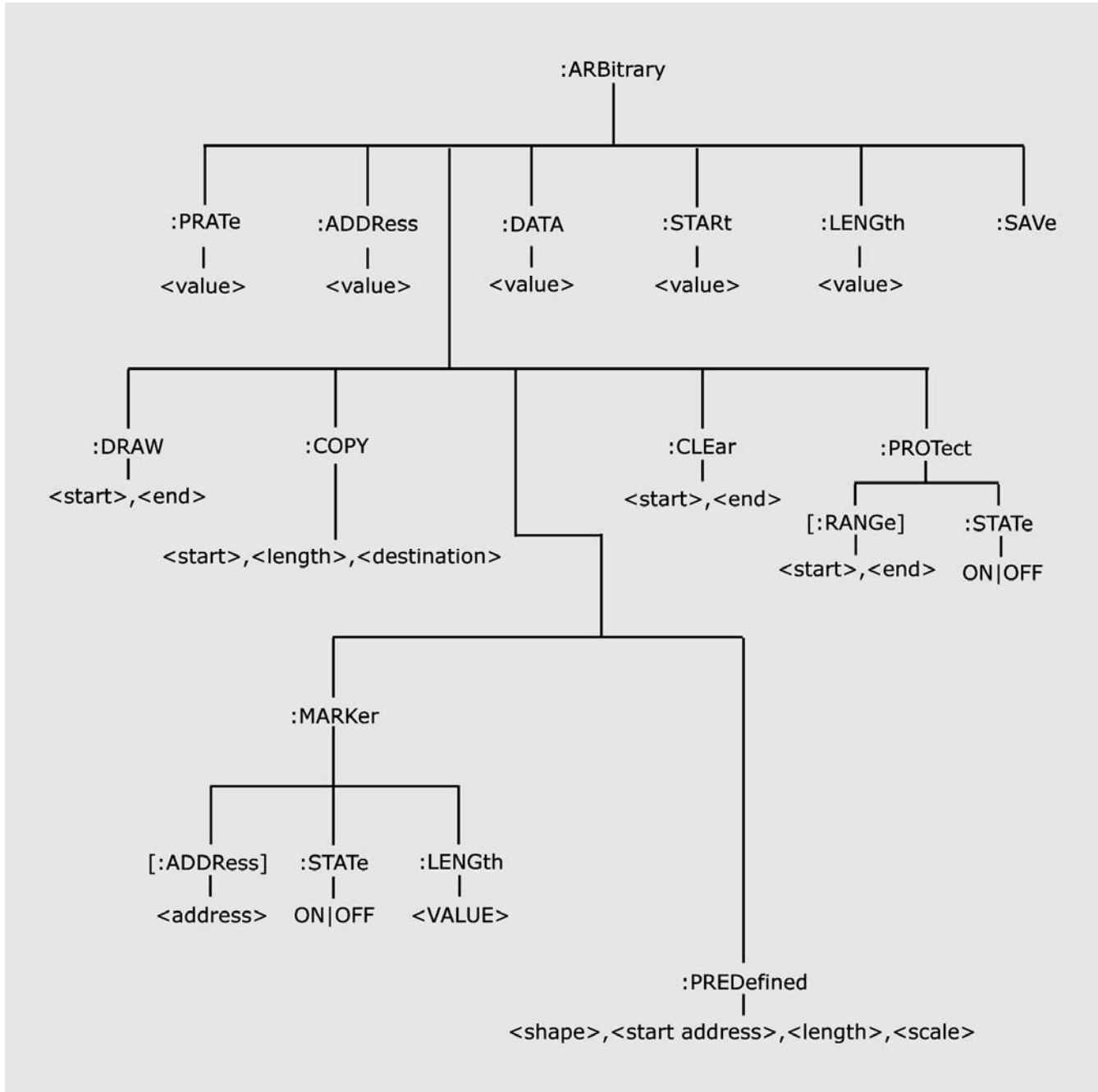

For Channel 2 Use: ARB2 or ARbitrary2

*Figure 5.8 - :STATus Subsystem Tree*

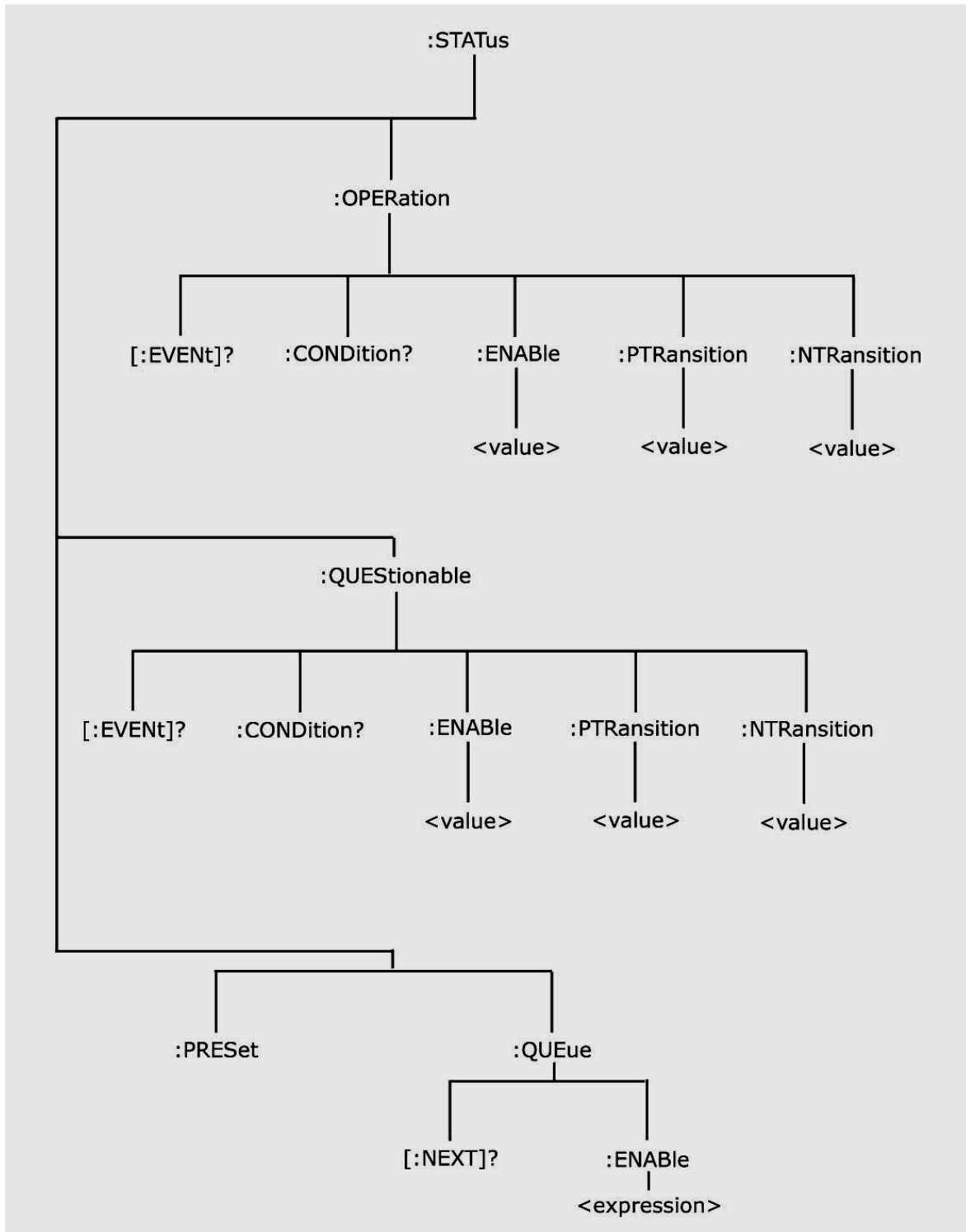

***STATus is a Global (System-Wide) Command***

*Figure 5.9 - :SYSTem Subsystem Tree*

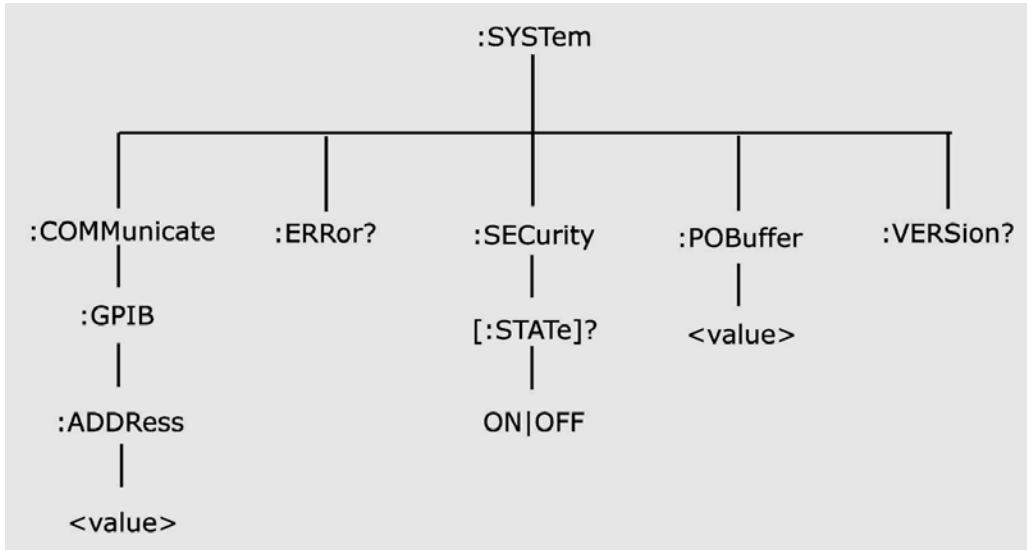

SYSTem is a Global (System-Wide) Command

Model 2732: Two Channel 50 MHz Function/Arbitrary Waveform Generator  
**Programming and Interfacing**

Table 5.8

ASCII & GPIB CODE CHART									
B7 B6 B5 BITS		0 0 0	0 0 1	0 1 0	0 1 1	1 0 0	1 0 1	1 1 0	1 1 1
B4 B3 B2 B1		CONTROL		NUMBERS SYMBOLS		UPPER CASE		LOWER CASE	
0 0 0 0		0 NUL	20 DLE	40 SP	60 0	100 @	120 P	140 ,	160 p
0 0 0 1		1 SOH	21 DC1	41 !	61 1	101 A	121 Q	141 a	161 q
0 0 1 0		2 STX	22 DC2	42 "	62 2	102 B	122 R	142 b	162 r
0 0 1 1		3 ETX	23 DC3	43 #	63 3	103 C	123 S	143 c	163 s
0 1 0 0		4 EOT	24 DC4	44 \$	64 4	104 D	124 T	144 d	164 t
0 1 0 1		5 ENQ	25 NAK	45 %	65 5	105 E	125 U	145 e	165 u
0 1 1 0		6 ACK	26 SYN	46 &	66 6	106 F	126 V	146 f	166 v
0 1 1 1		7 BEL	27 ETB	47 ,	67 7	107 G	127 W	147 g	167 w
1 0 0 0		8 BS	30 CAN	50 (	70 8	110 H	130 X	150 h	170 x
1 0 0 1		9 HT	31 EM	51 )	71 9	111 I	131 Y	151 i	171 y
1 0 1 0		10 LF	32 SUB	52 *	72 :	112 J	132 Z	152 j	172 z
1 0 1 1		11 VT	33 ESC	53 +	73 ;	113 K	133 [	153 k	173 {
1 1 0 0		12 FF	34 FS	54 ,	74 <	114 L	134 \	154 l	174 
1 1 0 1		13 CR	35 GS	55 -	75 =	115 M	135 ]	155 m	175 }
1 1 1 0		14 SO	36 RS	56 .	76 >	116 N	136 ^	156 n	176 ~
1 1 1 1		15 SI	37 US	57 /	77 ?	117 O	137 _	157 o	177 DEL (RUBOUT)
		ADDRESSED COMMANDS	UNIVERSAL COMMANDS	LISTEN ADDRESSES		TALK ADDRESSES		SECONDARY ADDRESSES OR COMMANDS (PPE)	(PPO)

octal 25 PPU GPIB code  
**NAK** ASCII character  
 hex 15 21 decimal



## Block Transfer

Arbitrary waveform data sent in IEEE488.2 arbitrary block format may take two forms: the definite form and the indefinite form. The essential difference between these forms is that the definite form contains a byte count, while the indefinite form does not. In both cases, the format of the command is

```
:ARB:DATA<ws><preamble><data><terminator>.
```

The <data> represents the arbitrary waveform data. This field consists of 8 bit bytes sent in hexadecimal form. Each arbitrary data point consists of two bytes with the high byte being sent first. When sending data in this way, the value of a data point may range from - 8191 (corresponding to the negative peak), to 8191 (corresponding to the positive peak). The value 0 corresponds to zero baseline. Compare the ASCII, or front panel representation, which defines data in the range - 8191 to + 8191.

Example: to set a data value to zero, send the Hex bytes

```
0800
```

The definite form <preamb4> consists of two fields. The first is a single byte representing the number of digits in the byte count. The byte count is the second field in the preamble, and consists of decimal bytes (0-9), which, when taken together, give the byte count. For example, the preamble

```
42563
```

means that the byte count consists of 4 bytes, and that the byte count is 2563 bytes. The indefinite form preamble consists of a 0 character alone. Both the definite and indefinite forms have a '#' prefix in the preamble.

Another difference is that the indefinite form, since it does not contain a byte count, must be terminated with LF^EOI.

Since each arbitrary data point consists of two bytes, an even number of bytes must be sent. In the following examples, the data is specified in Hex format with each byte being preceded by '\x', in order to show this.

Example of definite form:

```
:ARB:DATA #16\x8\x0\x8\x1\x8\x2
```

Here, the byte count consists of one byte only, and the value is 6.

Example to definite form:

```
:ARB:DATA #0\x8\x0\x8\x1\x8\x2\x0A
```

The '\x0A' represents the Linefeed character. EOI must be sent with this character. Arbitrary data read from the instrument in binary form, as opposed to ASCII, are returned in indefinite form.

Before sending your data enable all errors to be reported, using

```
:STAT:QUEUE:ENABLE ALL.
```

Then, if the arb data command causes an error, the error message may be read from the queue using the query.

```
:SYST:ERR?
```

## **GPIB Communication Protocol**

### *General*

This appendix describes the effects of interface messages on waveform generator operation and uses abbreviations from the IEEE Standard 488.1-1987.

### *Responses to IEEE-488.1 Interface Messages*

Interface messages and the effects of those messages on the instrument interface functions are defined in IEEE Standard 488.1-1987. Where appropriate, the GPIB code is listed, in decimal.

UNL-Unlisten (63 with ATN)  
UNT-Untalk (95 with ATN)

The UNL command places the listener function to its idle (unaddressed) state. In this idle state, the waveform generator cannot accept commands from the GPIB.

The UNT command places the talker function to its idle state. In this idle state, the waveform generator cannot output data through the GPIB.

When the talker and listener functions are idle, the front-panel ADRS indicator is off. If the waveform generator is talk-addressed or listen-addressed, the ADRS indicator lights.

### IFC-Interface Clear (Bus pin 9)

The IFC message places both the listener and talk functions to idle states. When the talker and listener functions are idle, the front-panel ADRS indicator is off.

The IFC pulse is  $\geq 100\mu\text{s}$ .

### DCL-Device Clear (20 with ATN)

The Device Clear message resets GPIB communication. That is, the DCL message clears all input and output messages, as well as all unexecuted settings.

### SDC-Selected Device Clear (4 with ATN)

The SDC message causes the same response as the DCL message. However, the waveform generator only responds if it is listen-addressed.

#### GET-Group Execute Trigger (8 with ATN)

The waveform generator responds to the Group Execute Trigger message only if it is listen addressed and the device trigger function is enabled. The TRIGger:MODE must be in TRIG, CONTinuous, or BURst and the TRIGger:SOURce must be set to BUS to enable device triggering via GET.

#### SPE-Serial Poll Enable (24 with ATN)

The SPE message generates output serial poll status bytes when talk-addressed.

#### SPD-Serial Poll Disable (25 with ATN)

The SPD message switches back to generating output data from the Output Buffer.

MLA-My Listen Address (GPIB Address + 32)

MTA-My Talk Address (GPIB Address + 64)

The instrument GPIB primary address establishes the listen and talk addresses. To see the current GPIB primary address, press SPECIAL and then F1:SYS on the front panel. When the waveform generator is talk-addressed or listen-addressed, the front-panel ADRS indicator lights.

#### LLO-Local Lockout (17 with ATN)

When the waveform generator is listen addressed, the LLO message changes the waveform generator to the front-panel lockout state.

#### REN-Remote Enable (GPIB pin 17)

REN is normally held true by the controller and allows the controller to then put the waveform generator into one of the remote states. Pulsing REN false or holding it false forces the device into local state (LOCS).

#### NOTE:

If you disconnect and reconnect the GPIB cable when the controller is holding REN true, the REN goes false and the device got to local state (LOCS).

### GTL-Go To Local (1 with ATN)

Listen-addressed instruments respond to GTL by changing to a local state. Remote-to-local transitions caused by GTL do not affect the execution of the message being processed when GTL was received.

### Remote-Local Operation

Most front-panel controls cause a transition from REMS to LOCS by asserting a message called return-to-local (rtl). This transition can occur during message execution. However, in contrast to TGL and REN transitions, a transition initiated by rtl affects message execution. In this case, the waveform generator generates an error if there are any unexecuted setting or operational commands.

Front-panel controls that change only the display, do not affect the remote-local states. Only front-panel controls that change settings assert rtl. The rtl message remains asserted when you enter multiple keystroke settings from the front panel, and is unasserted after you execute the settings changes. Since rtl prevents transition to REMS, the waveform generator unasserts rtl if you do not complete a multiple key sequence in a reasonable length of time (about 5 to 10 seconds).

A record of the front-panel settings is in the Current Settings Buffer; however, new settings entered from the front panel or the controller update these recorded settings. In addition, the front panel updates to reflect setting changes from controller commands. Settings are unaffected by transitions among the 4 remote-local states. The REMOTE indicator lights when the waveform generator is in REMS or RWLS.

### Local State (LOCS)

When in a local state (LOCS), you control the settings through the front-panel controls. In addition, only GPIB query commands are executed. All other GPIB commands, settings and operations prompt an error since those commands are under front-panel (local) control.

#### NOTE:

The waveform generator can be in either Local State (LOCS) or Remote State (REMS) when it receives the Local Lockout (LLO) interface message. If in LOCS and REN is asserted, the waveform generator enters the Local With Lockout State (LWLS) or, if in REMS, it enters the Remote With Lockout State (RWLS) when it receives LLO. The controller controls the LWLS and RWLS state transitions.

#### Local Without Lockout State (LWLS)

When the waveform generator is in a local without lockout state (LWLS), it operates the same as it does in LOCS. However, in LWLS rtl does not inhibit a transition to remote state.

#### Remote State (REMS)

When the waveform generator is in a remote state (REMS), you control its operations from the controller. All settings update when GPIB are executed.

#### Remote With Lockout State (RWLS)

When in a remote with lockout state (RWLS), the waveform generator operates much the same as it does in LOCS. However, when in RWLS the waveform generator ignores the rtl message, locking out any changes made from the front panel.

#### ***IEEE 488.2 Interface Function Subsets***

IEEE Standard 488.2 identifies the interface function repertoire of a device on the bus in terms of interface function subsets. These subsets are defined in the standard. Table C-1 lists the subsets that apply to the waveform generator.

#### NOTE:

For more information, refer to IEEE Standard 488.2. The standard is published by the Institute of Electrical and Electronics Engineers, Inc., 345 East 47 Street, New York, New York 10017.

**Table 5.9: Interface Function Subsets**

<b>FUNCTION</b>	<b>SUBSET</b>	<b>CAPABILITY</b>
Source Handshake	SH1	Complete capability
Acceptor Handshake	AH1	Complete capability
Basic Talker	T6	Responds to Serial Poll, Untalk if My Listen Address (MLA) is received
Basic Listener	L4	Unlisten if My Talk Address (MTA) is received
Service Request	SR1	Complete capability
Remote-Local	RL1	Complete capability, including Local Lockout (LLO)
Parallel Poll	PP0	Does not respond to Parallel Poll
Device Clear	DC1	Complete capability
Device Trigger	DT1	Complete capability
Controller	C0	No controller functions
Electrical Interface	E2	Three-state drive capability

INSTRUMENT DESCRIPTION  
PREPARATION FOR USE  
QUICK START INSTRUCTIONS  
OPERATING INSTRUCTIONS  
PROGRAMMING & INTERFACING  
**SERVICE INFORMATION**  
APPENDIX



Model 2732: Two Channel 50 MHz Function/Arbitrary Waveform Generator  
**Service Information**

---

## Service Information

---

### Warranty:

TEGAM, Inc. warrants this product to be free from defects in material and workmanship for a period of three years from the date of shipment. During this warranty period, if a product proves to be defective, TEGAM Inc., at its option, will either repair the defective product without charge for parts and labor, or exchange any product that proves to be defective.

TEGAM, Inc. warrants the calibration of this product for a period of 12 months from date of shipment. During this period, TEGAM, Inc. will recalibrate any product, which does not conform to the published accuracy specifications.

In order to exercise this warranty, TEGAM, Inc., must be notified of the defective product before the expiration of the warranty period. The customer shall be responsible for packaging and shipping the product to the designated TEGAM service center with shipping charges prepaid. TEGAM Inc. shall pay for the return of the product to the customer if the shipment is to a location within the country in which the TEGAM service center is located. The customer shall be responsible for paying all shipping, duties, taxes, and additional costs if the product is transported to any other locations. Repaired products are warranted for the remaining balance of the original warranty, or 90 days, whichever period is longer.

### Warranty Limitations:

*The TEGAM, Inc. warranty does not apply to defects resulting from unauthorized modification or misuse of the product or any part. This warranty does not apply to fuses, batteries, or damage to the instrument caused by battery leakage.*

### Statement of Calibration:

This instrument has been inspected and tested in accordance with specifications published by TEGAM Inc. The accuracy and calibration of this instrument are traceable to the National Institute of Standards and Technology through equipment, which is calibrated at planned intervals by comparison to certified standards maintained in the laboratories of TEGAM Inc.

### Contact Information:

TEGAM INC.  
10 TEGAM WAY  
GENEVA, OHIO 44041  
PH: 440.466.6100  
FX: 440.466.6110

*EMAIL: [sales@tegam.com](mailto:sales@tegam.com)*

Model 2732: Two Channel 50 MHz Function/Arbitrary Waveform Generator  
**Service Information**

---

### **Repair Parts**

The Model 2732 has no user replaceable parts. Available accessories are listed in Section I.

## Service Information

---

### **Troubleshooting:**

The TEGAM Model 2732 has been designed to provide many years of trouble free performance. However, there are some instances where harsh operating environments or excessive physical strain may cause premature failure. Should a malfunction of the 2732 be observed, it is recommended that certain steps be taken in order to assist our service department in identifying the cause of the malfunction and to provide the quickest possible turn around time for the repair cycle.

Below is a summary of some commonly observed symptoms and some possible remedies for ruling out the possibilities of user error or environmentally-related problems.

**No Display** – The display is completely blank.

- Check the power supply. Make sure that the AC line is operational and is supplying power to the unit.
- Check the fuse located in the rear panel. If a blown fuse is identified there is usually a reason for the fuse blowing, so the probability of another related problem is high.

### **Preparation for Repair or Calibration Service:**

Once you have verified that the cause for the 2732 problem cannot be solved in the field and the need for repair and calibration service arises, contact TEGAM customer service to obtain an RMA, (Returned Material Authorization), number. You can contact TEGAM customer service via the TEGAM website, [www.tegam.com](http://www.tegam.com) or by calling 440.466.6100 OR 800.666.1010.

The RMA number is unique to your instrument and will help us identify your instrument and to address the particular service request by you which is assigned to that RMA number. Of even greater importance, a detailed written description of the problem should be attached to the instrument. Many times repair turnaround is unnecessarily delayed due to a lack of repair instructions or of a detailed description of the problem.

This description should include information such as measurement settings, type of components being tested, whether the problem is intermittent or constant, when is the problem most frequent, has the test changed since the last time the instrument was used, etc.. Any detailed information provided to our technicians will assist them in identifying and correcting the problem in the quickest possible manner. Use the Expedite Repair & Calibration form provided on the next page.

Once this information is prepared and sent with the instrument and RMA number to our service department, we will do our part in making sure that you receive the best possible turnaround.



## Model 2732 Performance Verification:

### Introduction

This section provides a procedure to verify that the Model 2732 has met the specifications published in the manual to within stated tolerances. *There are no user accessible calibration points in the unit.* TEGAM, Inc. recommends an annual calibration verification interval. It is recommended that the Operating Section of the instruction manual should be followed in order to verify proper operation of the unit. Copy the Verification Test Sheet at the end of this chapter to record the data.

### Test Equipment Required

Analog Oscilloscope: 200 MHz or greater bandwidth.

Frequency Counter: 1 ppm or better accuracy.

True RMS Digital Multimeter: 5-1/2 digit, 0.1% or better accuracy.

Distortion Analyzer: 0.01% or better THD measurement at 80 kHz bandwidth.

Precision Load: 50 $\Omega$ , +/- 0.1%

### Environmental Conditions

These tests are to be performed at a temperature of 25°C,  $\pm 5^\circ\text{C}$  (77°F,  $\pm 9^\circ\text{F}$ ) with a relative humidity of less than 80%. Allow the instrument to warm up for at least one hour before performing these tests.

### Verification Test

#### Frequency Accuracy

1. Connect the frequency counter input to the 10 MHz CLK Output on the rear panel.
2. Verify that the output frequency is 10 MHz,  $\pm 20$  ppm

*The following procedures require the instrument to be reset to the default settings. Please save pertinent waveform data contained in the 2732 to a PC or disk before proceeding to the next test*

*Reset the instrument to the factory default settings by depressing [SETUPS], [F1], [0], [ENTER].*

#### Waveform Rise/Fall Time

*Use the shortest possible BNC cables when performing Rise/Fall time verification*

1. Set Amplitude to 10 Vp-p.
2. Depress the [WAVE] switch. Depress [F2] to select the Square Wave.
3. Connect **OUTPUT** to the oscilloscope input. Be sure it is terminated with the 50 $\Omega$  load.
4. Ensure that the **OUTPUT** [ON] indicator is active on the upper right hand corner of the LCD. If not, depress the [ON] switch above the **OUTPUT** connector.
5. Verify the rise and fall times of the square wave to be less than 6 ns (10% to 90%).
6. Repeat this process for Channel 2.

## Model 2732 Performance Verification cont'd:

### DC Offset Accuracy

1. Select a SINE wave with a frequency of 1 kHz and 1.00 V<sub>p-p</sub> amplitude.
2. Connect Channel 1 OUTPUT to the DMM input with the 50Ω load.
3. Set OFST to 4.50 V.
4. Set the DMM to DC measurement and verify the DC Offset measures between 4.445 V and 4.555 V.
5. Set OFST to 900 mV.
6. Verify that DC Offset measures between 0.881 V and 0.919 V.
7. Set OFST to 90 mV.
8. Verify that DC Offset from Channel 1 measures between 0.0791 V and 0.1009 V
9. Repeat this process for Channel 2.

### Amplitude Accuracy

1. Select a SINE wave with a frequency of 1 kHz and 0.00 V offset.
2. Connect **OUTPUT** to the DMM with the 50 Ω load.
3. Set the Amplitude to 10.00 V<sub>peak</sub>.
4. Measure the true RMS amplitude on the DMM.
5. Verify the true RMS amplitude is between 6.99 V<sub>RMS</sub> and 7.15 V<sub>RMS</sub>.
6. Set the Amplitude to 1.00 V<sub>peak</sub>.
7. Measure the true RMS amplitude on DMM.
8. Verify the true RMS amplitude is between 0.686 V<sub>RMS</sub> and 0.728 V<sub>RMS</sub>.
9. Repeat the process for Channel 2.

### Total Harmonic Distortion (THD) plus Noise

1. Use Channel 1 to select a SINE wave with 0.00 V offset.
2. Set the Amplitude to 9.10 V.
3. Set the Frequency to 20.00 kHz.
4. Connect Channel 1 OUTPUT to the distortion analyzer input using a 50Ω load.
5. Set the distortion analyzer for a 20 kHz signal and 80 kHz measurement bandwidth.
6. Verify THD + Noise measures less than -65 dBc.
7. Repeat the process for Channel 2.



Model 2732: Two Channel 50 MHz Function/Arbitrary Waveform Generator  
**Service Information**

---

**Model 2732 Channel 1 Performance Verification:**

Model:   Tegam 2732    
 Date: \_\_\_\_\_  
 Serial No. \_\_\_\_\_  
 Tested by: \_\_\_\_\_

TEGAM Model 2732 Channel 1 Verification Test						
Test Parameters (Both Channels)		Limits			Test	
		Low	Nominal	High	Pass	Fail
Frequency Accuracy (System)	Specification	9.9998 MHz	10.0000 MHz	10.0002 MHz		
	Test Data					
Rise/Fall Time	Specification	< 6 ns				
	Test Data					
DC Offset	Specification 1	4.445 V	4.500 V	4.555 V		
	Test Data					
	Specification 2	0.881 V	0.900 V	0.919 V		
	Test Data					
	Specification 3	0.0791 V	0.090 V	0.1009 V		
	Test Data					
Amplitude	Specification 1	6.99 V <sub>RMS</sub>	7.07 V <sub>RMS</sub>	7.15 V <sub>RMS</sub>		
	Test Data					
	Specification 2	0.686 V <sub>RMS</sub>	0.707 V <sub>RMS</sub>	0.728 V <sub>RMS</sub>		
	Test Data					
THD	Specification	< - 65 dBc				
	Test Data					

Model 2732: Two Channel 50 MHz Function/Arbitrary Waveform Generator  
**Service Information**

---

**Model 2732 Channel 2 Performance Verification:**

Model:   Tegam 2732    
 Date: \_\_\_\_\_  
 Serial No. \_\_\_\_\_  
 Tested by: \_\_\_\_\_

TEGAM Model 2732 Channel 2 Verification Test						
Test Parameters (Both Channels)		Limits			Test	
		Low	Nominal	High	Pass	Fail
Rise/Fall Time	Specification	< 6 ns				
	Test Data					
DC Offset	Specification 1	4.445 V	4.500 V	4.555 V		
	Test Data					
	Specification 2	0.881 V	0.900 V	0.919 V		
	Test Data					
	Specification 3	0.0791 V	0.090 V	0.1009 V		
	Test Data					
Amplitude	Specification 1	6.99 V <sub>RMS</sub>	7.07 V <sub>RMS</sub>	7.15 V <sub>RMS</sub>		
	Test Data					
	Specification 2	0.686 V <sub>RMS</sub>	0.707 V <sub>RMS</sub>	0.728 V <sub>RMS</sub>		
	Test Data					
THD	Specification	< - 65 dBc				
	Test Data					

SPECIFICATIONS  
PREPARATION FOR USE  
QUICK START INSTRUCTIONS  
OPERATING INSTRUCTIONS  
PROGRAMMING & INTERFACING  
SERVICE INFORMATION  
**APPENDIX**



